

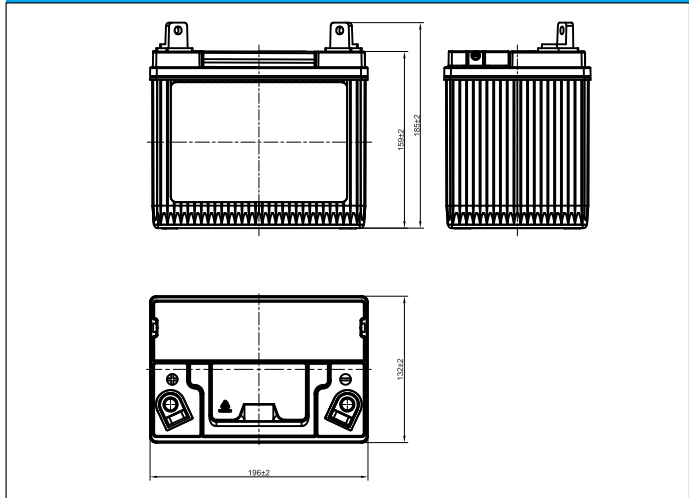

# BCI U1-355 (12V29Ah)



## Dimensions (mm)



## Physical Specification (mm)

Nominal Voltage		12V
Nominal Capacity(20HR)		29Ah
Dimension	Length	196±2mm(7.72inches)
	Width	132±2mm(5.20inches)
	Container Height	159±2mm(6.26inches)
	Total Height(with Terminal)	185±2mm(7.28inches)
Weight		Approx 8.4Kg(18.52lbs)
Acid		1.280±0.015g/cm <sup>3</sup> (25°C)
Standard Terminal		4
Cell layout		1
Hold-Down		B0
Cell plate qty		/
Case		Black-PP Material
Cover		Black-PP Material
Handle		Black-PP Material
QTY/PLT/layer		/

## Electrical Specification

Rated Capacity	20 hour rate(1.45A)	29Ah
Reserve Capacity		41min
Cold Cranking Performance Amps@0°F(-18°C)		355A

## Discharge Characteristics(25°C,70°F)

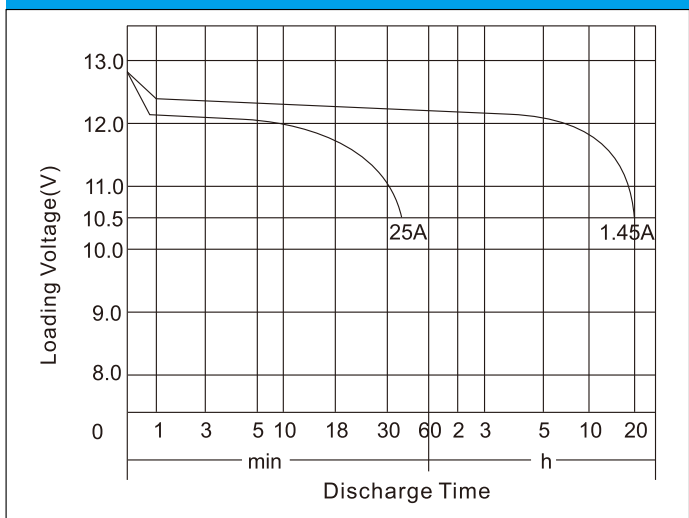

## Standard Terminal (mm)      Cell Layout

Terminal Type	4	<p>Figure(1)</p>

## Discharge Characteristics(-18°C,0°F)

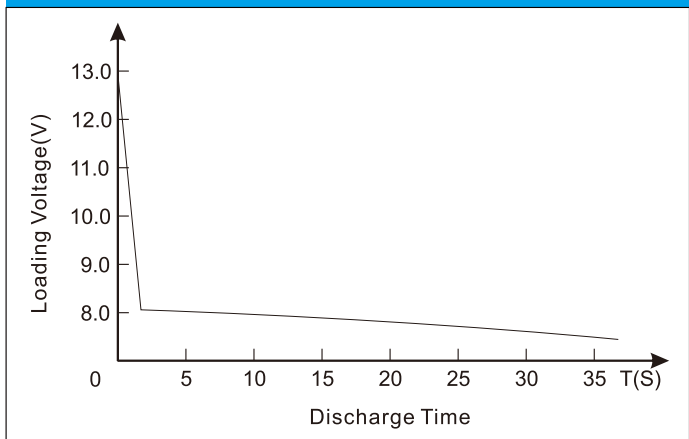

\*Values are subject to variation of +/- 5% in normal manufacturing processes.  
 \*Technical specifications and the product line above could be changed without prior notice.