

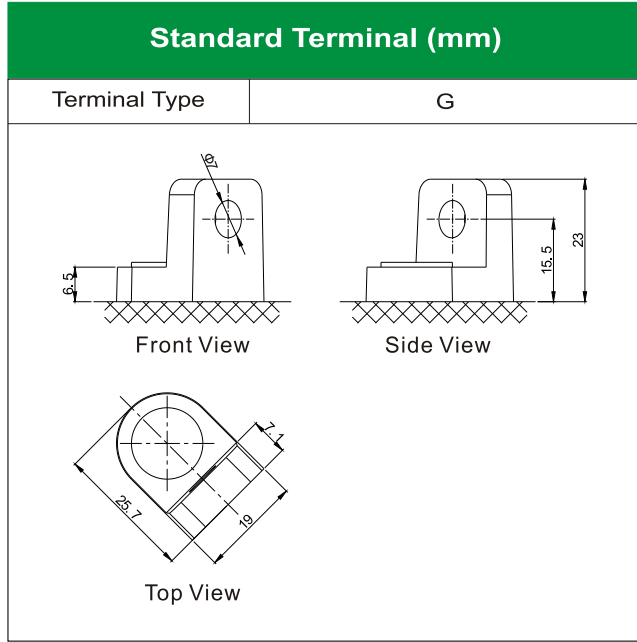

U1-12 [12V30Ah]

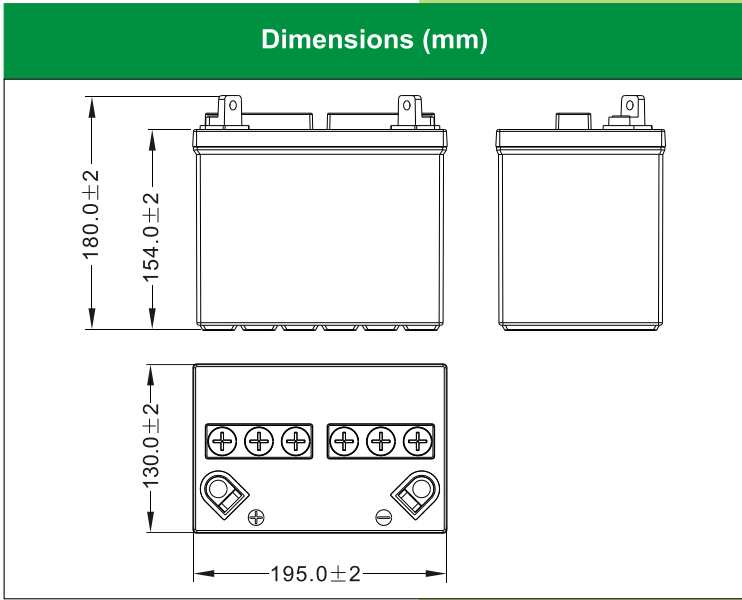
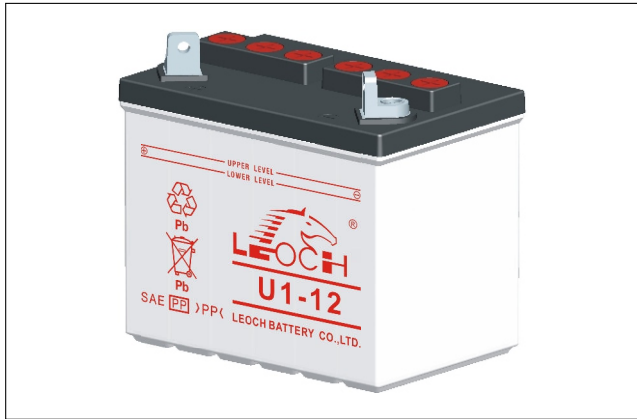

Physical Specification

Nominal Voltage		12V
Nominal Capacity (10HR)		30Ah
Dimension	Length	195 ± 2mm (7.68 inches)
	Width	130 ± 2mm (5.12 inches)
	Container Height	154 ± 2mm (6.06 inches)
	Total Height (with Terminal)	180 ± 2mm (7.09 inches)
Weight	Battery(with acid): Approx 8.52kg (18.79lbs) Electrolyte: Approx 2.52kg (5.56lbs)	
<ul style="list-style-type: none"> * High performance and dry charged high quality and flooded battery * Low maintenance * Powerful 300 cold cranking amps * Shipped without battery electrolyte pre-charged and ready to install * Replaces none battery 		

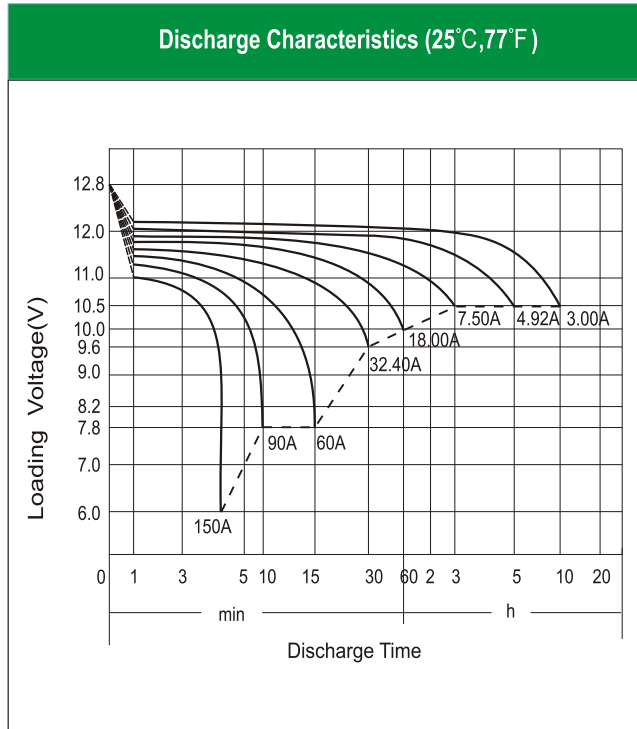

Electrical Specification

Rated Capacity	10 hour rate (3.00A)	30.00Ah
	5 hour rate (4.92 A)	24.60Ah
	2 hour rate (10.50A)	21.00Ah
	1 hour rate (18.00 A)	18.00Ah
	0.5 hour rate (32.40A)	16.20Ah
Capacity affected by Temperature	40 °C (104 °F)	106%
	25 °C (77 °F)	100%
	0 °C (32 °F)	86%
	-15 °C (5 °F)	65%
Charging Methods	Full Charge	Constant-Voltage Charge: Initial charging current: less than 9.0A Voltage: 14.40 V ~ 15.00 V at 25 °C (77 °F) Charging time: 16 ~24h Constant-Current Charge: Charging current: 3.0A, when charging voltage up to 15.60V, continue to charge 2h.
	Floating Charge	No limit on Initial charging current Voltage: 13.50 V ~ 13.80 V at 25 °C (77 °F)