

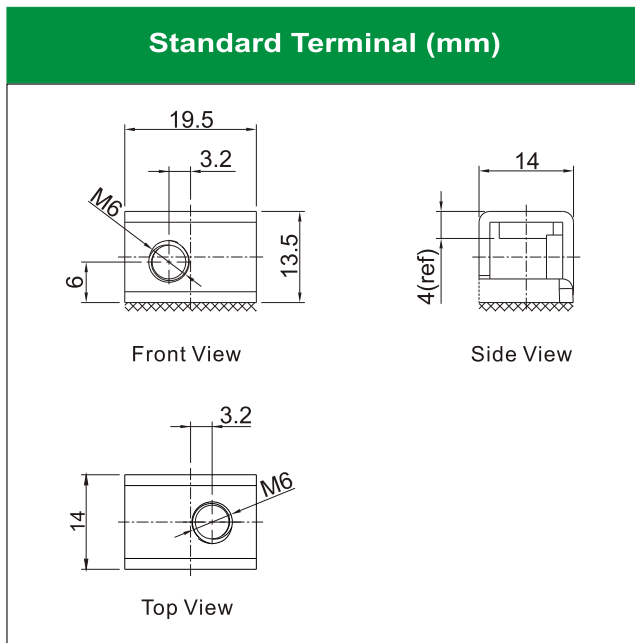

MX16-3 [12V19Ah]

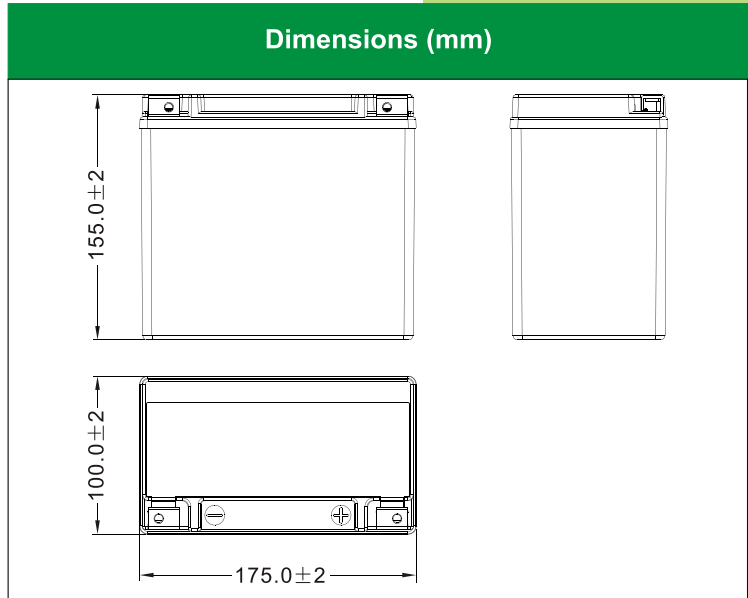

Physical Specification

Nominal Voltage		12V
Nominal Capacity (10HR)		19Ah
Dimension	Length	175 ± 2mm (6.89 inches)
	Width	100 ± 2mm (3.94 inches)
	Container Height	155 ± 2mm (6.10 inches)
	Total Height (with Terminal)	155 ± 2mm (6.10 inches)
Weight	Battery(with acid): Approx 7.15kg (15.77lbs)	
	Electrolyte: Approx 1.3kg (2.87lbs)	

- * Sealed and non-spillable AGM battery
- * Maintenance-free
- * Powerful 350 cold cranking amps
- * Shipped pre-charged and ready to install

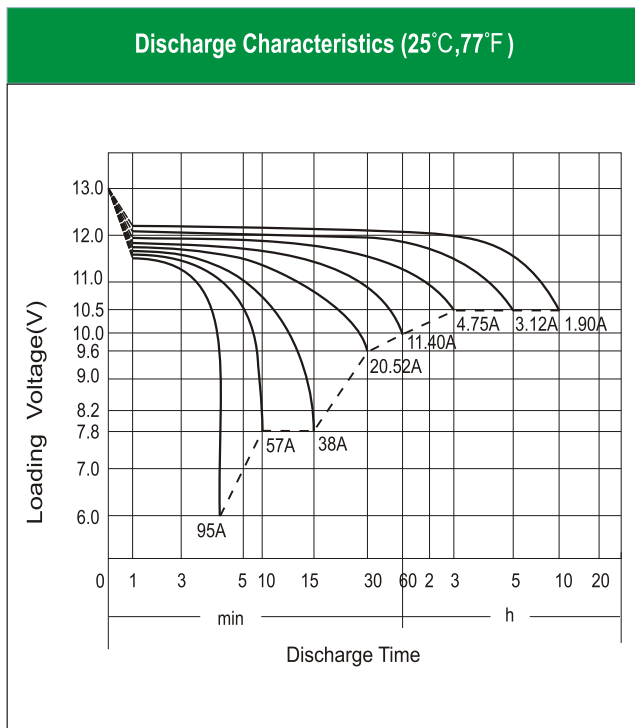

Electrical Specification

Rated Capacity	10 hour rate (1.90 A)	19.00Ah
	5 hour rate (3.12 A)	15.58Ah
	2 hour rate (6.65 A)	13.30Ah
	1 hour rate (11.40 A)	11.40Ah
	0.5 hour rate (20.52 A)	10.26Ah
Capacity affected by Temperature	40 °C (104 °F)	106%
	25 °C (77 °F)	100%
	0 °C (32 °F)	86%
	-15 °C (5 °F)	65%
Charging Methods	Full Charge	Constant-Voltage Charge: Initial charging current: less than 5.7A Voltage: 14.40 V ~ 15.00 V at 25 °C (77 °F) Charging time: 15 ~18h Constant-Current Charge: Charging current: 0.1C ₁₀ =1.90A, when charging voltage up to 14.40V, continue to charge 4h
	Floating Charge	No limit on Initial charging current Voltage: 13.50 V ~ 13.80 V at 25 °C (77 °F)