



# LRC Series-Lead Carbon

## LRC2-300



### Specifications

Rated Voltage	2V	
Nominal Capacity	321Ah	(C <sub>10</sub> , 1.80V/cell)
Dimension	Length	158mm (6.22 in.)
	Width	181mm (7.13 in.)
	Container Height	350mm (13.78 in.)
	Total Height	365mm (14.37 in.)
Approx Weight	24.8 Kg (54.7 lbs)	
Terminal	M8	
Container Material	ABS Flame Retardant Material to UL94V-0	
Rated Capacity (25°C)	396.0 Ah	C120(3.30A, 1.85V/cell)
	300.0 Ah	C10(30.0A, 1.80V/cell)
	225.0 Ah	C3(75.0A, 1.80V/cell)
	165.0 Ah	C1(165.0A, 1.75V/cell)
Short Circuit Current	5120A	
Internal Resistance(25°C)	Approx.0.4mΩ	
Operating Temp.Range	Discharge	-20°C~55°C (-4°F~131°F)
	Charge	-20°C~40°C (-4°F~104°F)
	Storage	-20°C~50°C (-4°F~122°F)
Nominal Operating Temp. Range	25±3°C (77±5°F)	
Max.Discharging Current(25°C)	150.0A	
Max.Charging Current(25°C)	90.0A	
Charge voltage(25°C)	Cycle(Equalization)	2.30~2.40V
	Temp. Coefficient	-4mV/cell/°C
Effect of temp. to Capacity	40°C (104°F)	106%
	25°C (77°F)	100%
	0°C (32°F)	86%
Self Discharge	≤3.5% per month at 25°C	

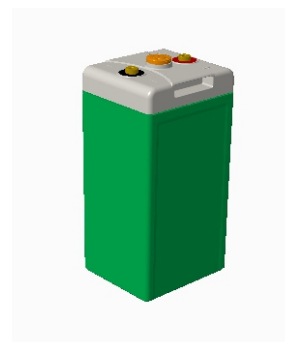

### Layout

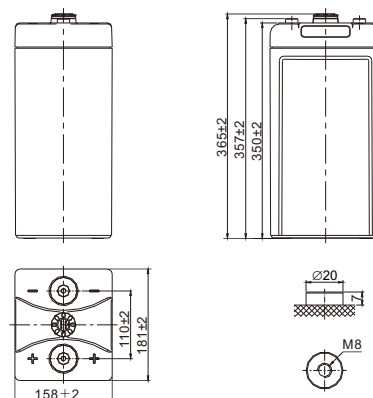

### Constant Current Discharge (Amperes) at 25 °C (77 °F)

F.V/Time	1h	2h	3h	4h	5h	6h	8h	10h	24h	36h	48h	60h	72h	84h	96h	108h	120h	240h
1.90V/cell	116.6	81.8	61.9	53.0	44.3	38.4	31.2	26.8	13.2	8.96	6.88	/	/	/	/	/	/	1.70
1.85V/cell	128.4	87.5	68.3	56.7	47.5	41.3	33.6	29.0	14.4	9.75	7.49	6.10	5.20	4.50	4.00	3.60	3.30	/
1.80V/cell	153.1	93.3	75.0	58.8	49.2	42.8	34.8	30.0	14.7	10.0	7.64	/	/	/	/	/	/	/
1.75V/cell	165.0	98.0	76.8	60.0	50.2	43.7	35.5	30.6	15.0	10.2	7.80	/	/	/	/	/	/	/

### Constant Power Discharge (Watts/cell) at 25 °C (77 °F)

F.V/Time	1h	2h	3h	4h	5h	6h	8h	10h	24h	36h	48h	60h	72h	84h	96h	108h	120h	240h
1.90V/cell	228.2	162.7	125.0	106.9	89.6	77.8	63.2	54.5	25.5	17.2	13.2	/	/	/	/	/	/	3.40
1.85V/cell	251.9	173.2	136.2	113.2	95.2	82.8	67.6	58.5	26.5	17.9	13.8	12.2	10.4	9.00	8.00	7.20	6.60	/
1.80V/cell	295.4	180.8	147.5	117.0	98.4	85.6	69.9	60.5	27.4	18.6	14.3	/	/	/	/	/	/	/
1.75V/cell	310.2	188.4	150.3	119.0	100.0	86.9	70.8	61.2	28.4	19.2	14.8	/	/	/	/	/	/	/



# LRC Series-Lead Carbon

## LRC2-300

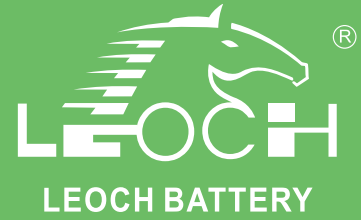

### Applications

- Mobile container storage system
- Peak load shifting energy storage system
- Load tracking energy storage system
- Oil and electricity hybrid energy storage system
- Grid frequency adjustment energy storage system
- New energy communication base station, IDC, UPS etc.
- New energy generation (solar, wind, PV/wind hybrid) access to energy storage systems

### General Features

- Design life  $\geq 15$  years
- Adopt super carbon technology + deep cycle technology
- Excellent charging acceptance and super fast charge/large discharge performance
- Modular design and installation for less space, easy installation & maintenance
- Innovative robust design to ensure superb safety and reliability
- Horizontal installation, solve the problem of electrolyte stratification

### Standards

- Compliance with IEC 61427, BS EN 61427 standards
- UL, CE Certified
- Manufactured in Leoch@TS16949, IOS 45001, IOS 9001 and ISO14001 certified production facilities

### Discharge Characteristics

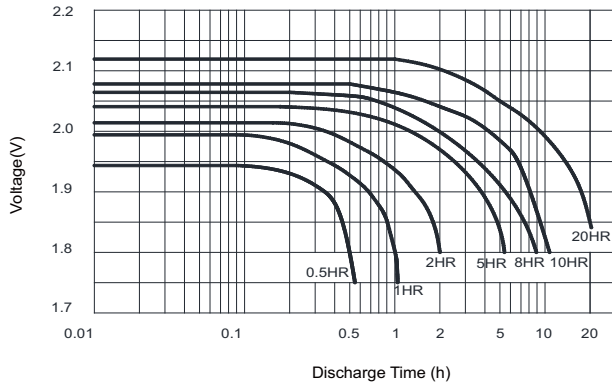

### Temperature effects in relation to battery capacity

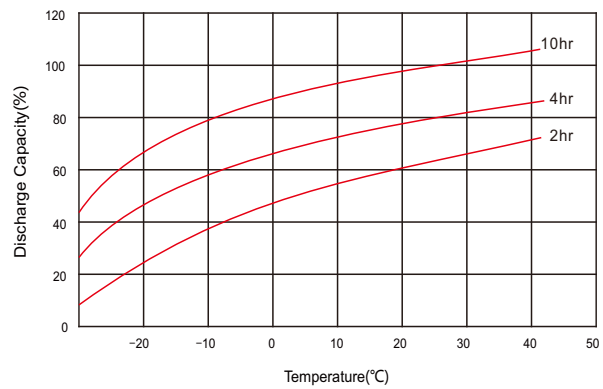

### Cycle Life in Relation to DOD

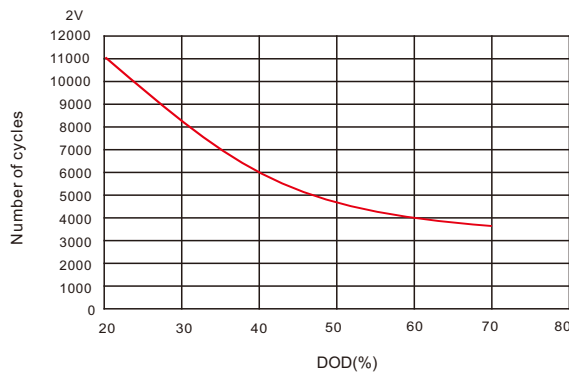

### Self Discharge Characteristics

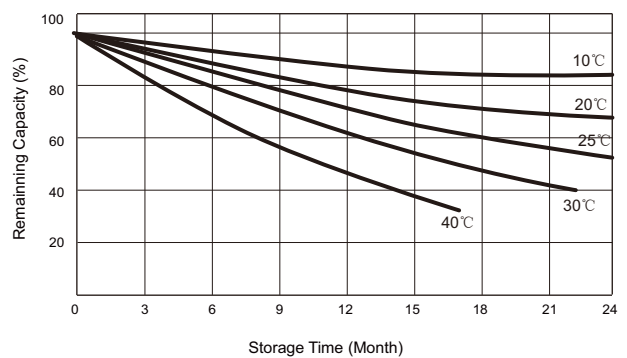

## Sales Offices Worldwide

#### China Sales Office

5th Floor, Xinhaohui Bldg., Nanhai Blvd.,  
Nanshan, Shenzhen, China. 518052  
Tel: +86-755-86036060 (100 lines)  
Fax: +86-755-26067269  
E-mail: export@leoch.com

#### HongKong Sales Office

Workshop C, 33/F, TML Tower, No. 3 Hoi Shing Road,  
Tsuen Wan, New Territories, Hong Kong  
Tel: +852 35786666  
Fax: +44 1452 690125  
E-mail: sales.hk@leoch.com

#### Singapore Sales Office

No. 1 Tech Park Crescent,  
Singapore 638131  
Tel: +65 68636078  
Fax: +65 6863 6079  
Email: sales.sg@Leoch.com

#### Australia Sales Office

2 /29 Tarlington Place, Smithfield. NSW 2164  
Australia  
Tel: 02 9756 0950  
E-mail: sales.au@leoch.com

#### North America Sales Office

19751 Descartes  
Foothill Ranch, CA 92610, USA  
Tel: 949-588-5853  
Fax: 949-588-5966  
E-mail: sales@leoch.us

#### UK Sales Office

9B Wheatstone Court. Waterwells, Business Park,  
Gloucester, GL2-2AQ, UK United Kingdom  
Tel: +44(0) 1452 729428 / 1452 729696  
Fax: +44 1452 690125  
E-mail: Sales.Europe@leoch.com

#### EMEA Sales Office

1 Deligiorgi St., 121 31 Athens,  
Greece  
Tel: +30 210 5760318 (2 lines)  
E-mail: support\_EMEA@leoch.com

#### India Sales Office

Shed no.A-53(b), 2nd Stage of Peenya Industrial Area,  
Bangalore North Taluk, Bangalore-560058, India  
Tel: +91-80-23440018/23440019  
Fax: +91-80-23440017  
E-mail: indiasales@leoch.com



<http://www.leoch.com>

<http://www.leoch.us>

© 2020 LEOCH. All rights reserved.

Trademarks and logos are the property of LEOCH and its affiliates unless otherwise noted.  
Subject to revisions without prior notice.

Publication No.:LB-LRC2-300-PD-EN-V1.2-202005