

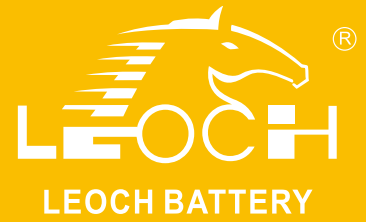

LPL Series-Long Life Standby LPL2-600M(2V600Ah)



Specifications

Rated Voltage	2V	
Nominal Capacity	C ₁₀ , 1.80V/cell	600Ah
Dimension	Length	225±2mm (8.56 inches)
	Width	181±2mm (7.13 inches)
	Container Height	350±2mm (13.8 inches)
	Total Height	365±2mm (14.4 inches)
Approx Weight	33.1 Kg (73.0 lbs)	
Terminal	M8	
Container Material	ABS	
Rated Capacity(25°C)	636.0 Ah	(20hr, 31.8A, 1.80V/cell)
	600.0 Ah	(10hr, 60.0A, 1.80V/cell)
	525.0 Ah	(5hr, 105.0A, 1.75V/cell)
	468.0 Ah	(3hr, 156.0A, 1.75V/cell)
	375.4 Ah	(1hr, 375.4A, 1.60V/cell)
Max. Discharge Current	4800A (5s)	
Internal Resistance(25°C)	Approx 0.4mΩ	
Operating Temp. Range	Discharge	-15 ~ 50°C (5 ~ 122°F)
	Charge	-20 ~ 40°C (-4 ~ 104°F)
	Storage	-15 ~ 40°C (5 ~ 104°F)
Nominal Operating Temp. Range	25±3°C (77±5°F)	
Standby Use	Initial Charging Current less than 180A. Voltage 2.23V~2.27V at 25°C(77°F)Temp. Coefficient -3mV/°C	
Equalization Use	Initial Charging Current less than 180A. Voltage 2.35V~2.40V at 25°C(77°F)Temp. Coefficient -4mV/°C	
Cycle Use	Initial Charging Current less than 180A. Voltage 2.40V~2.50V at 25°C(77°F)Temp. Coefficient -5mV/°C	
Effect of temp. to Capacity	40°C (104°F)	103%
	25°C (77°F)	100%
	0°C (32°F)	86%
Self Discharge	LPL series batteries may be stored for up to 6 months at 25°C(77°F) and then a freshening charge is required. For higher temperatures the time interval will be shorter.	



Layout

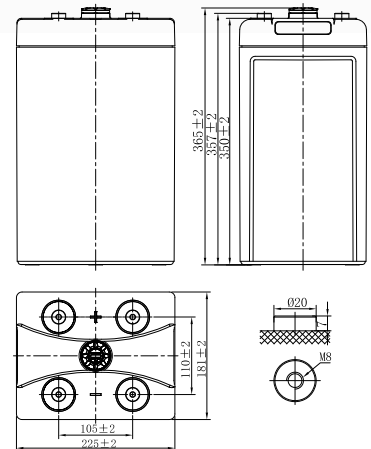

Constant Current Discharge (Amperes) at 25 °C (77°F)

F.V/Time	30min	1h	1.5h	2h	3h	4h	5h	6h	8h	10h	20h
1.85V/cell	383.9	262.6	241.3	183.0	140.4	113.0	95.3	82.7	67.2	56.2	30.1
1.80V/cell	421.9	313.2	249.2	193.9	151.9	121.8	102.7	88.8	72.0	60.0	31.8
1.75V/cell	490.1	337.6	260.1	202.8	156.0	124.8	105.0	90.6	73.3	60.9	32.2
1.70V/cell	529.1	354.9	272.0	209.7	160.6	127.9	107.4	92.6	74.6	61.9	32.6
1.67V/cell	544.0	361.1	273.0	210.0	163.0	129.7	108.7	93.7	75.4	62.4	32.9
1.60V/cell	566.9	375.4	274.8	219.4	169.0	134.0	112.1	96.3	77.2	63.8	33.4

Constant Power Discharge (Watts/cell) at 25 °C (77°F)

F.V/Time	30min	1h	1.5h	2h	3h	4h	5h	6h	8h	10h	20h
1.85V/cell	730.8	587.4	467.7	356.6	275.3	222.0	187.6	163.1	132.9	111.3	59.9
1.80V/cell	785.4	617.2	477.5	374.2	296.7	238.4	201.5	174.5	142.0	118.6	63.2
1.75V/cell	900.4	649.0	496.0	389.8	303.3	243.5	205.4	177.7	144.3	120.2	63.9
1.70V/cell	957.9	658.7	513.5	396.5	310.7	248.7	209.5	181.1	146.5	121.9	64.7
1.67V/cell	974.8	665.3	516.3	399.6	314.5	251.6	211.7	182.9	147.9	122.8	65.1
1.60V/cell	1048.2	701.1	520.1	417.6	324.2	258.6	217.2	187.3	150.9	125.1	66.2



LPL Series-Long Life Standby LPL2-600M(2V600Ah)

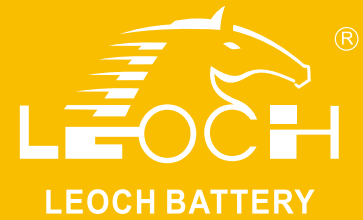

Applications

- Tele-communication central station (wired or cellular)
- Power system communication, military communication, etc.
- Network communication including: data transmission, television signal transmission, etc.
- Uninterruptable Power System (UPS- for Telecom)
- EPS

General Features

- 16 years design life(25°C)
- Grid refining technology and the thicker plates are used to extend the battery standby life and reduce the plate grid corrosion speed
- Using oxygen recombination technology: maintenance-free
- Unique vent valve design: control water losing, prevent air and spark going inside

Standards

- Compliance with IEC 60896 standards, EU Battery Directive
- UL, CE Certified
- Manufactured in Leoch@IATF16949, ISO 45001,ISO 9001 and ISO 14001 certified production facilities

Discharge Characteristics

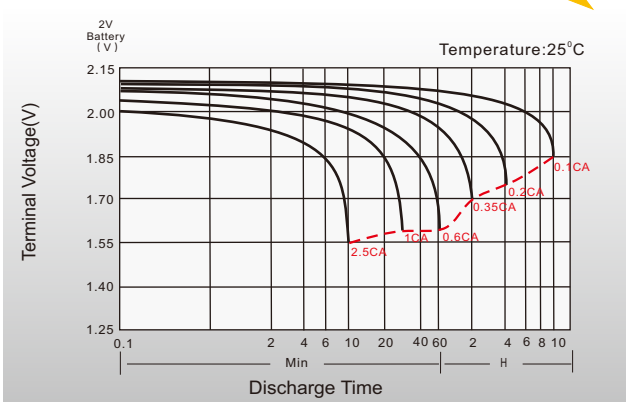

Float Charging Characteristics

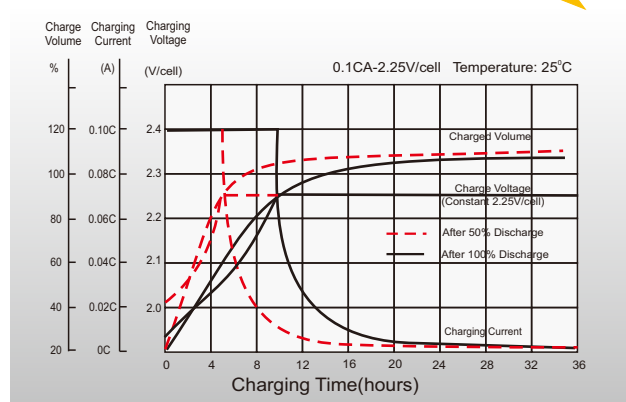

Temperature Effects in Relation to Battery Capacity

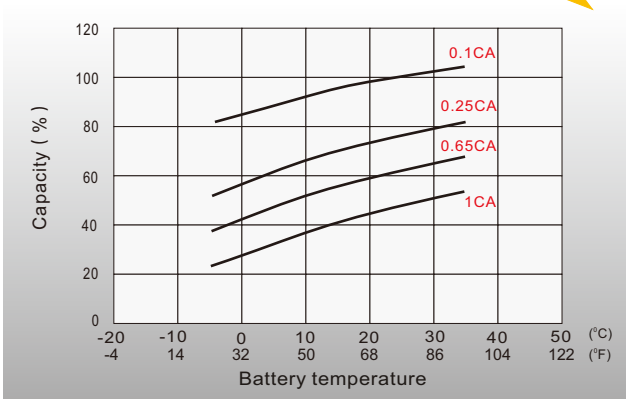

Effect of Temperature on Long Term Float Life

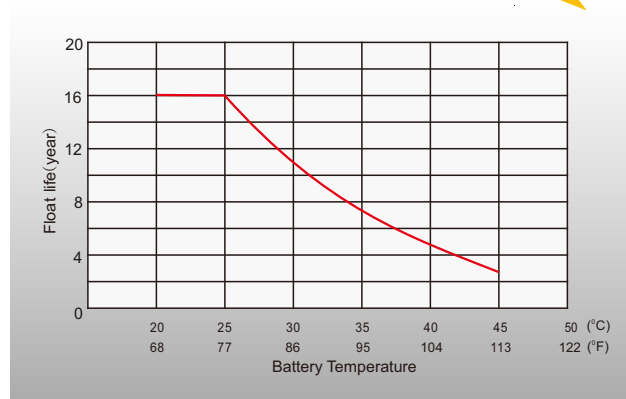

Sales Offices Worldwide

China Sales Office

5th Floor, Xinbaohui Bldg., Nanhai Blvd.,
Nanshan, Shenzhen, China. 518052
Tel: +86-755-86036060 (100 lines)
Fax: +86-755-26067269
E-mail: export@leoch.com

HongKong Sales Office

Workshop C, 33/F, TML Tower, No. 3 Hoi Shing Road,
Tsuen Wan, New Territories, Hong Kong
Tel: +852 35786666
Fax: +44 1452 690125
E-mail: sales.hk@leoch.com

Singapore Sales Office

No. 1 Tech Park Crescent,
Singapore 638131
Tel: +65 68636078
Fax: +65 6863 6079
Email: sales.sg@Leoch.com

Australia Sales Office

2/29 Tarlington Place, Smithfield. NSW 2164
Australia
Tel: +91-80-23440018/23440019
E-mail: sales.au@leoch.com

North America Sales Office

19751 Descartes
Foothill Ranch, CA 92610, USA
Tel: 949-588-5853
Fax: 949-588-5966
E-mail: sales@leoch.us
Http://www.leoch.us

UK Sales Office

9B Wheatstone Court, Waterwells, Business Park,
Gloucester, GL2-2AQ, UK United Kingdom
Tel: +44(0) 1452 729428 / 1452 729696
Fax: +44 1452 690125
E-mail: Sales.Europe@leoch.com
Http://www.leoch.eu

EMEA Sales Office

1 Deligiorgi St., 121 31 Athens,
Greece
Tel: +30 210 5760318 (2 lines)
E-mail: support_EMEA@leoch.com
Http://www.leoch.eu

India Sales Office

Shed no. A-53(b), 2nd Stage of Peenya Industrial Area,
Bangalore North Taluk, Bangalore-560058, India
Tel: +91-80-23440018/23440019
Fax: +91-80-23440017
E-mail: indiasales@leoch.com



[Http://www.leoch.com](http://www.leoch.com)

© 1999-2020 LEOCH. All rights reserved.

Trademarks and logos are the property of LEOCH and its affiliates unless otherwise noted.

Subject to revisions without prior notice.

Publication No.: LB-LPL2-600M-PD-EN-V2.1-202011