

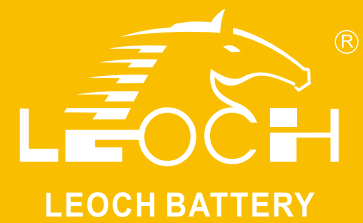

# LP Series-General Purpose LP12-55(12V55Ah)



## Specifications

Rated Voltage	12V	
Nominal Capacity	55.0Ah	(C <sub>10</sub> , 1.80V/cell)
Dimension	Length	229±2mm (9.02 inches)
	Width	138±2mm (5.43 inches)
	Container Height	205±2mm (8.07 inches)
	Total Height	211±2mm (8.31 inches)
Approx Weight	16.2 Kg (35.7 lbs)	
Terminal	M6	
Container Material	ABS	
Rated Capacity (25°C)	57.8 Ah	(20hr, 2.89A, 1.80V/cell)
	55.0 Ah	(10hr, 5.50A, 1.80V/cell)
	50.0 Ah	(5hr, 10.0A, 1.75V/cell)
	45.6 Ah	(3hr, 15.2A, 1.75V/cell)
	35.1 Ah	(1hr, 35.1A, 1.60V/cell)
Max. Discharge Current	550A (5s)	
Internal Resistance (25°C)	Approx 9.0mΩ	
Operating Temp. Range	Discharge	-15 ~ 50°C (5 ~ 122°F)
	Charge	0 ~ 40°C (32 ~ 104°F)
	Storage	-15 ~ 40°C (5 ~ 104°F)
Nominal Operating Temp. Range	25±3°C (77±5°F)	
Cycle Use	Initial Charging Current less than 16.5A. Voltage 14.4V~15.0V at 25°C(77°F)Temp. Coefficient -30mV/°C	
	Initial Charging Current less than 16.5A. Voltage 13.5V~13.8V at 25°C(77°F)Temp. Coefficient -20mV/°C	
Effect of temp. to Capacity	40°C (104°F)	103%
	25°C (77°F)	100%
	0°C (32°F)	86%
Self Discharge	LP series batteries may be stored for up to 6 months at 25°C(77°F) and then a freshening charge is required. For higher temperatures the time interval will be shorter.	

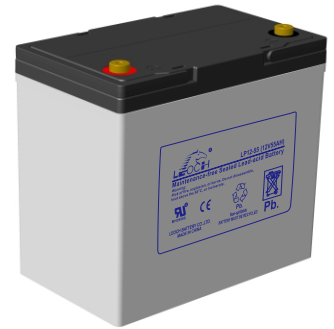

## Layout

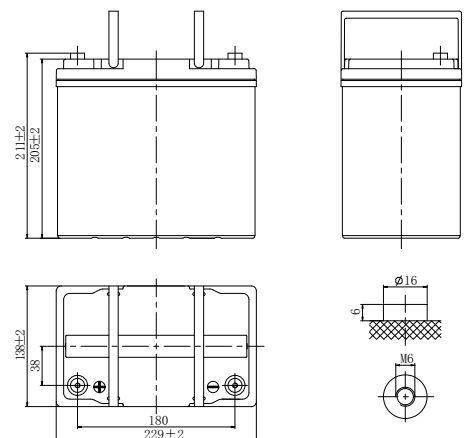

## Constant Current Discharge (Amperes) at 25 °C (77°F)

F.V/Time	5min	10min	15min	20min	30min	45min	1h	1.5h	2h	3h	4h	5h	6h	8h	10h	20h
1.85V/cell	112.1	79.7	70.5	55.5	49.6	36.3	30.7	22.3	18.7	13.7	10.8	9.35	8.24	6.34	5.25	2.79
1.80V/cell	127.5	90.5	79.9	62.7	54.0	38.4	31.8	23.0	19.3	14.9	11.5	9.83	8.86	6.67	5.50	2.89
1.75V/cell	138.5	98.2	86.5	67.7	55.1	39.8	33.4	24.2	20.4	15.2	11.7	10.0	8.93	6.70	5.56	2.92
1.70V/cell	148.1	104.7	91.9	71.8	56.2	40.6	34.1	24.7	20.8	15.5	11.9	10.2	8.97	6.81	5.61	2.95
1.67V/cell	153.3	108.0	94.6	73.8	57.0	41.2	34.6	25.1	21.1	15.6	12.1	10.4	9.01	6.90	5.68	2.98
1.60V/cell	158.7	111.7	97.5	75.7	57.9	41.8	35.1	25.4	21.4	15.8	12.2	10.5	9.08	6.99	5.75	3.02

## Constant Power Discharge (Watts/cell) at 25 °C (77°F)

F.V/Time	5min	10min	15min	20min	30min	45min	1h	1.5h	2h	3h	4h	5h	6h	8h	10h	20h
1.85V/cell	203.0	145.4	133.6	105.5	94.8	69.7	59.4	43.2	36.4	26.8	21.1	18.4	16.3	12.6	10.4	5.55
1.80V/cell	227.1	162.7	149.4	118.0	102.4	73.4	61.2	44.4	37.4	29.0	22.5	19.3	17.4	13.2	10.9	5.74
1.75V/cell	242.4	173.6	159.5	126.0	103.7	75.6	64.0	46.5	39.2	29.5	22.8	19.6	17.5	13.2	11.0	5.79
1.70V/cell	254.8	182.5	167.6	132.4	104.9	76.6	64.9	47.2	39.9	29.9	23.1	19.8	17.6	13.4	11.1	5.84
1.67V/cell	259.0	185.5	170.4	134.6	105.6	77.3	65.5	47.7	40.3	30.1	23.4	20.2	17.6	13.6	11.2	5.91
1.60V/cell	262.6	188.1	172.8	136.5	106.1	77.7	66.0	48.0	40.6	30.2	23.6	20.4	17.7	13.7	11.4	5.97



# LP Series-General Purpose LP12-55(12V55Ah)



## Applications

- All purpose
- Uninterruptable Power Supply (UPS)
- Electric Power System (EPS)
- Emergency backup power supply
- Alarm and security system
- Communication power supply
- DC power supply
- Auto control system

## General Features

- 8 years design life(25°C)
- Special exhaust structure and sealing technology, safe and reliable, flexible installation, convenient maintenance
- PbCaSn alloy for plate grids: less gassing, less self-discharging
- High quality AGM separator: extend cycle life and prevent micro short circuit
- High purity raw material: ensure low self discharge rate

## Standards

- Compliance with IEC 60896 standards, EU Battery Directive
- UL, CE Certified
- Manufactured in Leoch®IATF 16949, ISO45001, ISO 9001 and ISO 14001 certified production facilities

## Discharge Characteristics

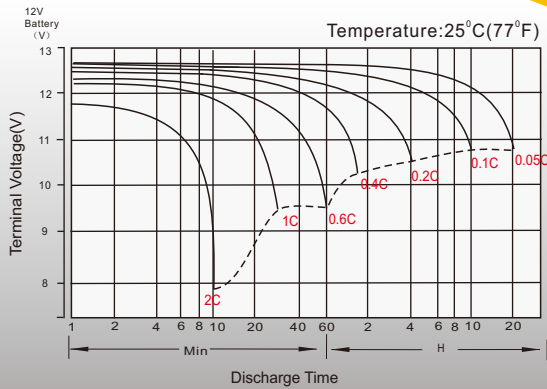

## Float Charging Characteristics

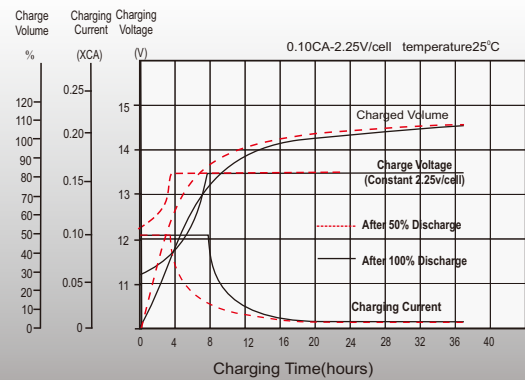

## Temperature Effects in Relation to Battery Capacity

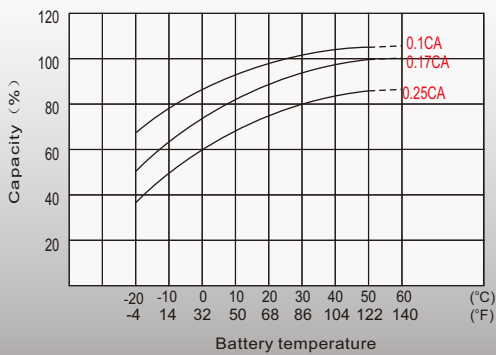

## Float Service Life

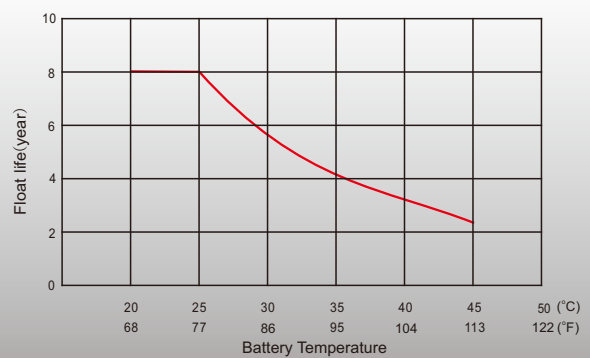

## Sales Offices Worldwide

### China Sales Office

5th Floor, Xinbaohui Bldg., Nanhai Blvd.,  
Nanshan, Shenzhen, China. 518052  
Tel: +86-755-86036060 (100 lines)  
Tel: +86-755-26067269  
E-mail: export@leoch.com

### HongKong Sales Office

Workshop C, 33/F, TML Tower, No. 3 Hoi Shing Road,  
Tsuen Wan, New Territories, Hong Kong  
Tel: +852 35786666  
Tel: +44(0) 1452 729428 / 1452 729696  
E-mail: sales.hk@leoch.com

### Singapore Sales Office

No. 1 Tech Park Crescent,  
Singapore 638131  
Tel: +65 68636078  
Tel: +65 6863 6079  
Email: sales.sg@Leoch.com

### Australia Sales Office

2 /29 Tarlington Place, Smithfield, NSW 2164  
Australia  
Tel: 02 9756 0950  
E-mail: sales.au@leoch.com

### North America Sales Office

19751 Descartes  
Foothill Ranch, CA 92610, USA  
Tel: 949-588-5853  
Tel: 949-588-5966  
E-mail: sales@leoch.us  
Http:// www.leoch.us

### UK Sales Office

9B Wheatstone Court, Waterwells, Business Park,  
Gloucester, GL2-2AQ, UK United Kingdom  
Tel: +44(0) 1452 729428 / 1452 729696  
Tel: +44 1452 690125  
E-mail: Sales.Europe@leoch.com  
Http:// www.leoch.eu

### EMEA Sales Office

1 Deligiorgi St., 121 31 Athens,  
Greece  
Tel: +30 210 5760318 (2 lines)  
Tel: +30 210 5760318 (2 lines)  
E-mail: support\_EMEA@leoch.com  
Http:// www.leoch.eu

### India Sales Office

Shed no.A-53(b), 2nd Stage of Peenya Industrial Area,  
Bangalore North Taluk, Bangalore-560058, India  
Tel: +91-80-23440018/23440019  
Tel: +91-80-23440017  
E-mail: indiasales@leoch.com



[Http://www.leoch.com](http://www.leoch.com)

© 2020 LEOCH. All rights reserved.

Trademarks and logos are the property of LEOCH and its affiliates unless otherwise noted.  
Subject to revisions without prior notice.

Publication No.: LB-LP12-55-PD-EN-V2.0-202004