

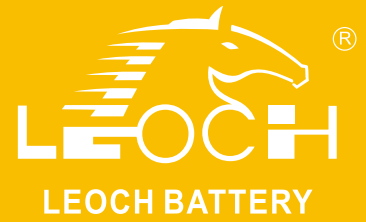

# LP Series-General Purpose LP12-100E(12V100Ah)



## Specifications

Rated Voltage	12V	
Nominal Capacity	100.0Ah	(C <sub>10</sub> , 1.80V/cell)
Dimension	Length	330±2mm (12.99 inches)
	Width	173±2mm (6.81 inches)
	Container Height	213±2mm (8.39 inches)
	Total Height	220±2mm (8.66 inches)
Approx Weight	28.2 Kg (62.2 lbs)	
Terminal	M8	
Container Material	ABS	
Rated Capacity (25°C)	103.0 Ah	(20hr, 5.15A, 1.80V/cell)
	100.0 Ah	(10hr, 10.0A, 1.80V/cell)
	89.0 Ah	(5hr, 17.8A, 1.75V/cell)
	81.3Ah	(3hr, 27.1A, 1.75V/cell)
	62.5 Ah	(1hr, 62.5A, 1.60V/cell)
Max. Discharge Current	1000A (5s)	
Internal Resistance (25°C)	Approx 4.9mΩ	
Operating Temp. Range	Discharge	-15 ~ 50°C (5 ~ 122°F)
	Charge	-20 ~ 40°C (-4 ~ 104°F)
	Storage	-15 ~ 40°C (5 ~ 104°F)
Nominal Operating Temp. Range	25±3°C (77±5°F)	
Cycle Use	Initial Charging Current less than 30.0A. Voltage 14.4V~15.0V at 25°C(77°F)Temp. Coefficient -30mV/°C	
	Initial Charging Current less than 30.0A. Voltage 13.5V~13.8V at 25°C(77°F)Temp. Coefficient -20mV/°C	
Effect of temp. to Capacity	40°C (104°F)	103%
	25°C (77°F)	100%
	0°C (32°F)	86%
Self Discharge	LP series batteries may be stored for up to 6 months at 25°C(77°F) and then a freshening charge is required. For higher temperatures the time interval will be shorter.	



## Layout

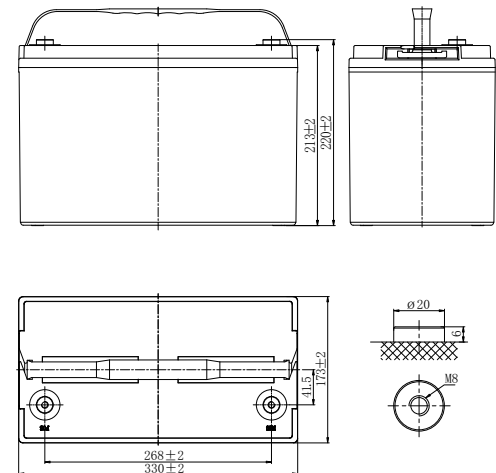

## Constant Current Discharge (Amperes) at 25 °C (77°F)

F.V/Time	5min	10min	15min	20min	30min	45min	1h	1.5h	2h	3h	4h	5h	6h	8h	10h	20h
1.85V/cell	195.7	139.2	125.7	98.9	88.4	64.6	54.7	39.7	33.4	24.5	19.2	16.7	14.7	11.3	9.36	4.96
1.80V/cell	222.6	158.0	142.4	111.8	96.2	68.5	56.7	41.0	34.4	26.6	20.5	17.5	15.8	11.9	10.0	5.15
1.75V/cell	241.8	171.3	154.2	120.7	98.2	71.0	59.5	43.1	36.3	27.1	20.9	17.8	15.9	11.9	10.1	5.20
1.70V/cell	258.5	182.7	163.8	127.9	100.2	72.4	60.7	44.0	37.0	27.6	21.2	18.1	16.0	12.1	10.2	5.25
1.67V/cell	267.5	188.5	168.6	131.4	101.6	73.4	61.6	44.6	37.5	27.9	21.6	18.5	16.1	12.3	10.3	5.31
1.60V/cell	277.0	194.9	173.8	134.8	103.1	74.5	62.5	45.3	38.1	28.1	21.8	18.8	16.2	12.5	10.4	5.38

## Constant Power Discharge (Watts/cell) at 25 °C (77°F)

F.V/Time	5min	10min	15min	20min	30min	45min	1h	1.5h	2h	3h	4h	5h	6h	8h	10h	20h
1.85V/cell	365.6	261.8	238.0	188.0	168.9	124.3	105.9	77.0	64.9	47.8	37.7	32.8	29.0	22.4	18.6	9.89
1.80V/cell	408.9	292.9	266.2	210.3	182.4	130.8	109.1	79.2	66.7	51.7	40.1	34.4	31.1	23.5	19.5	10.2
1.75V/cell	436.5	312.6	284.1	224.5	184.7	134.7	114.0	82.9	69.9	52.5	40.7	34.9	31.2	23.6	19.6	10.3
1.70V/cell	458.8	328.6	298.7	236.0	186.8	136.5	115.6	84.1	71.0	53.3	41.2	35.3	31.3	23.9	19.8	10.4
1.67V/cell	466.3	334.0	303.6	239.8	188.2	137.7	116.7	84.9	71.8	53.6	41.7	35.9	31.4	24.2	20.0	10.5
1.60V/cell	472.8	338.7	307.8	243.2	189.0	138.4	117.5	85.6	72.3	53.8	42.0	36.3	31.5	24.5	20.2	10.6



# LP Series-General Purpose LP12-100E(12V100Ah)

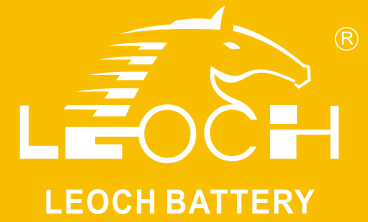

## Applications

- All purpose
- Uninterruptable Power Supply (UPS)
- Electric Power System (EPS)
- Emergency backup power supply
- Alarm and security system
- Communication power supply
- DC power supply
- Auto control system

## General Features

- 8 years design life(25°C)
- Special exhaust structure and sealing technology, safe and reliable, flexible installation, convenient maintenance
- PbCaSn alloy for plate grids: less gassing, less self-discharging
- High quality AGM separator: extend cycle life and prevent micro short circuit
- High purity raw material: ensure low self discharge rate

## Standards

- Compliance with IEC 60896 standards, EU Battery Directive
- UL, CE Certified
- Manufactured in Leoch®IATF 16949, ISO45001, ISO 9001 and ISO 14001 certified production facilities

## Discharge Characteristics

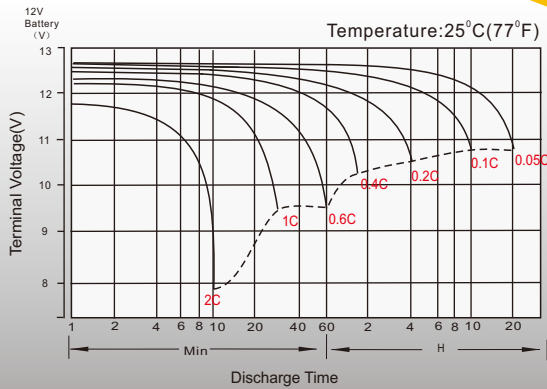

## Float Charging Characteristics

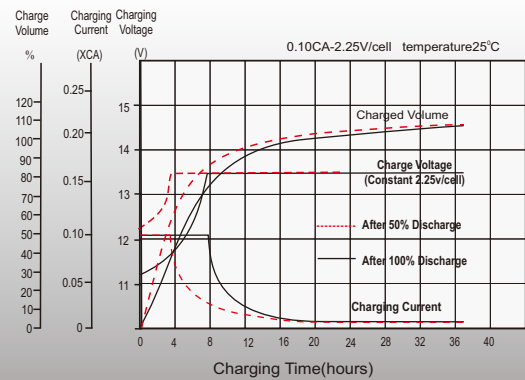

## Temperature Effects in Relation to Battery Capacity

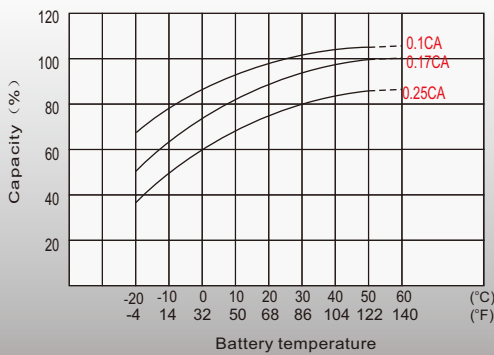

## Float Service Life

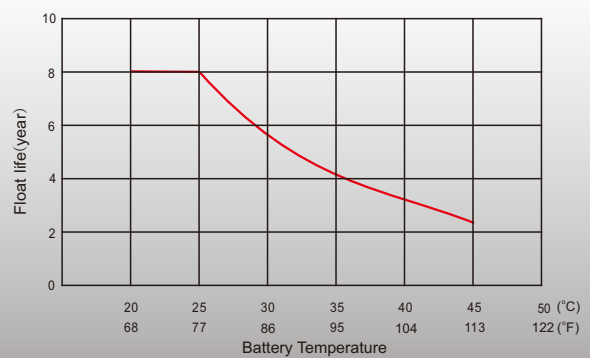

## Sales Offices Worldwide

### China Sales Office

5th Floor, Xinbaohui Bldg., Nanhai Blvd.,  
Nanshan, Shenzhen, China. 518052  
Tel: +86-755-86036060 (100 lines)  
Tel: +86-755-26067269  
E-mail: export@leoch.com

### HongKong Sales Office

Workshop C, 33/F, TML Tower, No. 3 Hoi Shing Road,  
Tsuen Wan, New Territories, Hong Kong  
Tel: +852 35786666  
Tel: +44(0) 1452 729428 / 1452 729696  
E-mail: sales.hk@leoch.com

### Singapore Sales Office

No. 1 Tech Park Crescent,  
Singapore 638131  
Tel: +65 68636078  
Tel: +65 6863 6079  
Email: sales.sg@Leoch.com

### Australia Sales Office

2 /29 Tarlington Place, Smithfield, NSW 2164  
Australia  
Tel: 02 9756 0950  
E-mail: sales.au@leoch.com

### North America Sales Office

19751 Descartes  
Foothill Ranch, CA 92610, USA  
Tel: 949-588-5853  
Tel: 949-588-5966  
E-mail: sales@leoch.us  
Http:// www.leoch.us

### UK Sales Office

9B Wheatstone Court, Waterwells, Business Park,  
Gloucester, GL2-2AQ, UK United Kingdom  
Tel: +44(0) 1452 729428 / 1452 729696  
Tel: +44 1452 690125  
E-mail: Sales.Europe@leoch.com  
Http:// www.leoch.eu

### EMEA Sales Office

1 Deligiorgi St., 121 31 Athens,  
Greece  
Tel: +30 210 5760318 (2 lines)  
Tel: +30 210 5760318 (2 lines)  
E-mail: support\_EMEA@leoch.com  
Http:// www.leoch.eu

### India Sales Office

Shed no.A-53(b), 2nd Stage of Peenya Industrial Area,  
Bangalore North Taluk, Bangalore-560058, India  
Tel: +91-80-23440018/23440019  
Tel: +91-80-23440017  
E-mail: indiasales@leoch.com



[Http://www.leoch.com](http://www.leoch.com)

© 2020 LEOCH. All rights reserved.

Trademarks and logos are the property of LEOCH and its affiliates unless otherwise noted.  
Subject to revisions without prior notice.

Publication No.: LB-LP12-100E-PD-EN-V2.0-202004