

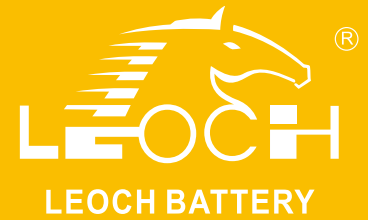

# LP Series-General Purpose LP12-100(12V100Ah)



## Specifications

Rated Voltage	12V	
Nominal Capacity	100.0Ah	(C <sub>10</sub> , 1.80V/cell)
Dimension	Length	330±2mm (12.99 inches)
	Width	173±2mm (6.81 inches)
	Container Height	212±2mm (8.35 inches)
	Total Height	220±2mm (8.66 inches)
Approx Weight	28.0 Kg (61.7 lbs)	
Terminal	M8	
Container Material	ABS	
Rated Capacity (25°C)	105.0 Ah	(20hr, 5.25A, 1.80V/cell)
	100.0 Ah	(10hr, 10.0A, 1.80V/cell)
	89.0 Ah	(5hr, 17.8A, 1.75V/cell)
	77.1 Ah	(3hr, 25.7A, 1.75V/cell)
	64.6 Ah	(1hr, 64.6A, 1.60V/cell)
Max. Discharge Current	1000A (5s)	
Internal Resistance (25°C)	Approx 5.0mΩ	
Operating Temp. Range	Discharge	-15 ~ 50°C (5 ~ 122°F)
	Charge	-20 ~ 40°C (-4 ~ 104°F)
	Storage	-15 ~ 40°C (5 ~ 104°F)
Nominal Operating Temp. Range	25±3°C (77±5°F)	
Cycle Use	Initial Charging Current less than 30.0A. Voltage 14.4V~15.0V at 25°C(77°F)Temp. Coefficient -30mV/°C	
	Initial Charging Current less than 30.0A. Voltage 13.5V~13.8V at 25°C(77°F)Temp. Coefficient -20mV/°C	
Standby Use	Initial Charging Current less than 30.0A. Voltage 13.5V~13.8V at 25°C(77°F)Temp. Coefficient -20mV/°C	
Effect of temp. to Capacity	40°C (104°F)	103%
	25°C (77°F)	100%
	0°C (32°F)	86%
Self Discharge	LP series batteries may be stored for up to 6 months at 25°C(77°F) and then a freshening charge is required. For higher temperatures the time interval will be shorter.	



## Layout

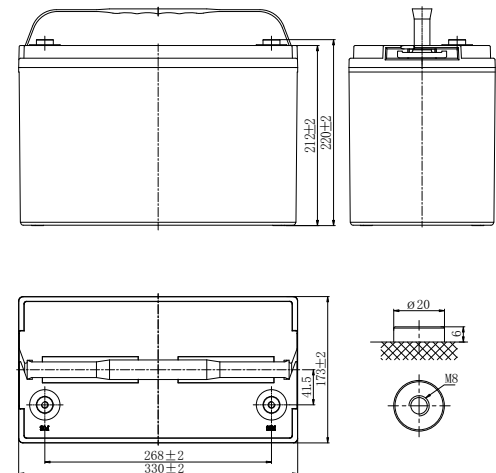

## Constant Current Discharge (Amperes) at 25 °C (77°F)

F.V/Time	15min	20min	30min	45min	1h	1.5h	2h	3h	4h	5h	6h	8h	10h	20h
1.85V/cell	152.8	119.2	82.5	67.5	52.5	35.5	29.9	23.8	19.4	16.6	15.0	11.7	9.39	4.93
1.80V/cell	170.3	132.8	92.0	73.8	55.6	37.5	31.5	25.0	20.3	17.2	15.5	12.0	10.0	5.25
1.75V/cell	177.7	138.6	96.0	77.5	59.0	39.7	33.0	25.7	21.1	17.8	15.9	12.2	10.2	5.36
1.70V/cell	179.9	140.3	97.2	79.5	61.7	41.5	34.2	26.5	21.6	18.1	16.2	12.4	10.3	5.41
1.67V/cell	182.7	142.5	98.7	81.3	63.9	42.9	35.2	27.3	22.1	18.4	16.5	12.6	10.4	5.46
1.60V/cell	185.5	144.7	100.2	82.4	64.6	44.0	35.8	27.8	22.4	18.7	16.7	12.7	10.5	5.51

## Constant Power Discharge (Watts/cell) at 25 °C (77°F)

F.V/Time	15min	20min	30min	45min	1h	1.5h	2h	3h	4h	5h	6h	8h	10h	20h
1.85V/cell	280.1	218.5	151.3	117.9	84.4	64.3	52.9	40.4	33.2	30.4	26.9	20.0	16.7	8.79
1.80V/cell	312.2	243.5	168.6	129.7	90.7	69.3	57.1	43.3	35.1	32.2	28.4	20.7	17.0	8.94
1.75V/cell	325.8	254.1	175.9	135.7	95.4	72.3	59.3	44.6	36.3	33.2	29.1	21.0	17.2	9.04
1.70V/cell	329.9	257.3	178.1	138.9	99.7	74.8	60.9	45.8	37.2	33.9	29.6	21.1	17.4	9.14
1.67V/cell	335.0	261.3	180.9	142.5	104.1	77.5	62.6	47.2	38.2	34.3	30.0	21.3	17.6	9.24
1.60V/cell	340.0	265.2	183.6	145.9	108.2	79.9	63.9	48.1	38.7	34.7	30.4	21.7	17.9	9.40



# LP Series-General Purpose LP12-100(12V100Ah)

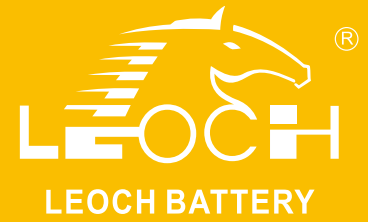

## Applications

- All purpose
- Uninterruptable Power Supply (UPS)
- Electric Power System (EPS)
- Emergency backup power supply
- Alarm and security system
- Communication power supply
- DC power supply
- Auto control system

## General Features

- 8 years design life(25°C)
- Special exhaust structure and sealing technology, safe and reliable, flexible installation, convenient maintenance
- PbCaSn alloy for plate grids: less gassing, less self-discharging
- High quality AGM separator: extend cycle life and prevent micro short circuit
- High purity raw material: ensure low self discharge rate

## Standards

- Compliance with IEC 60896 standards, EU Battery Directive
- UL, CE Certified
- Manufactured in Leoch®IATF 16949, ISO45001, ISO 9001 and ISO 14001 certified production facilities

## Discharge Characteristics

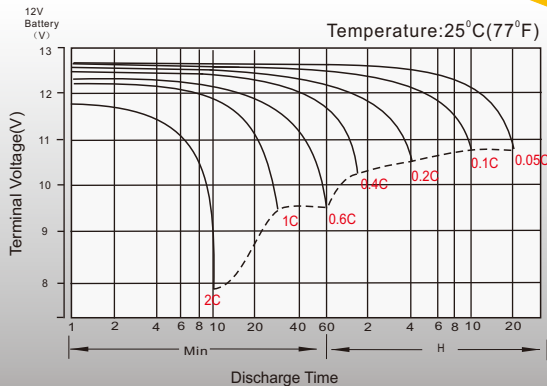

## Float Charging Characteristics

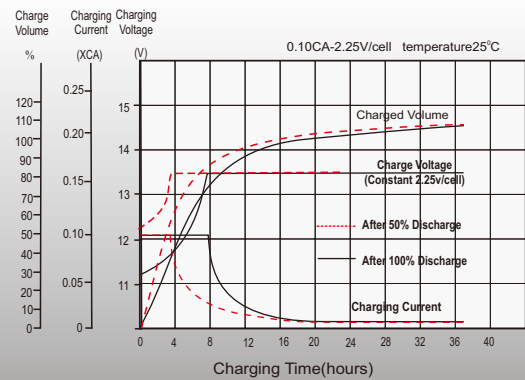

## Temperature Effects in Relation to Battery Capacity

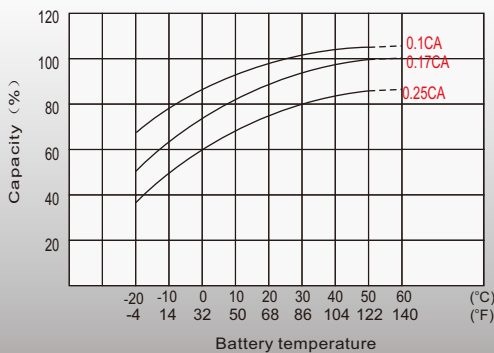

## Float Service Life

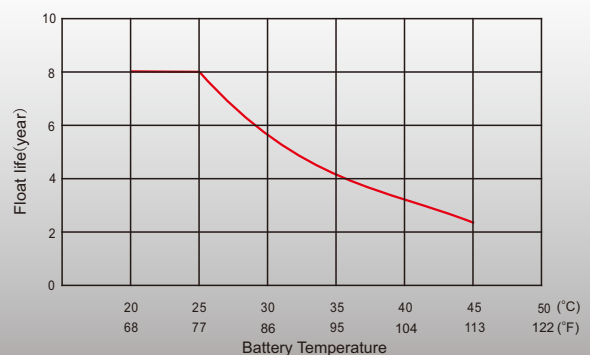

## Sales Offices Worldwide

### China Sales Office

5th Floor, Xinbaohui Bldg., Nanhai Blvd.,  
Nanshan, Shenzhen, China. 518052  
Tel: +86-755-86036060 (100 lines)  
Tel: +86-755-26067269  
E-mail: export@leoch.com

### HongKong Sales Office

Workshop C, 33/F, TML Tower, No. 3 Hoi Shing Road,  
Tsuen Wan, New Territories, Hong Kong  
Tel: +852 35786666  
Tel: +44(0) 1452 729428 / 1452 729696  
E-mail: sales.hk@leoch.com

### Singapore Sales Office

No. 1 Tech Park Crescent,  
Singapore 638131  
Tel: +65 68636078  
Tel: +65 6863 6079  
Email: sales.sg@Leoch.com

### Australia Sales Office

2 /29 Tarlington Place, Smithfield, NSW 2164  
Australia  
Tel: 02 9756 0950  
E-mail: sales.au@leoch.com

### North America Sales Office

19751 Descartes  
Foothill Ranch, CA 92610, USA  
Tel: 949-588-5853  
Tel: 949-588-5966  
E-mail: sales@leoch.us  
Http:// www.leoch.us

### UK Sales Office

9B Wheatstone Court, Waterwells, Business Park,  
Gloucester, GL2-2AQ, UK United Kingdom  
Tel: +44(0) 1452 729428 / 1452 729696  
Tel: +44 1452 690125  
E-mail: Sales.Europe@leoch.com  
Http:// www.leoch.eu

### EMEA Sales Office

1 Deligiorgi St., 121 31 Athens,  
Greece  
Tel: +30 210 5760318 (2 lines)  
Tel: +30 210 5760318 (2 lines)  
E-mail: support\_EMEA@leoch.com  
Http:// www.leoch.eu

### India Sales Office

Shed no.A-53(b), 2nd Stage of Peenya Industrial Area,  
Bangalore North Taluk, Bangalore-560058, India  
Tel: +91-80-23440018/23440019  
Tel: +91-80-23440017  
E-mail: indiasales@leoch.com



[Http://www.leoch.com](http://www.leoch.com)

© 2020 LEOCH. All rights reserved.

Trademarks and logos are the property of LEOCH and its affiliates unless otherwise noted.  
Subject to revisions without prior notice.

Publication No.: LB-LP12-100-PD-EN-V2.0-202004