

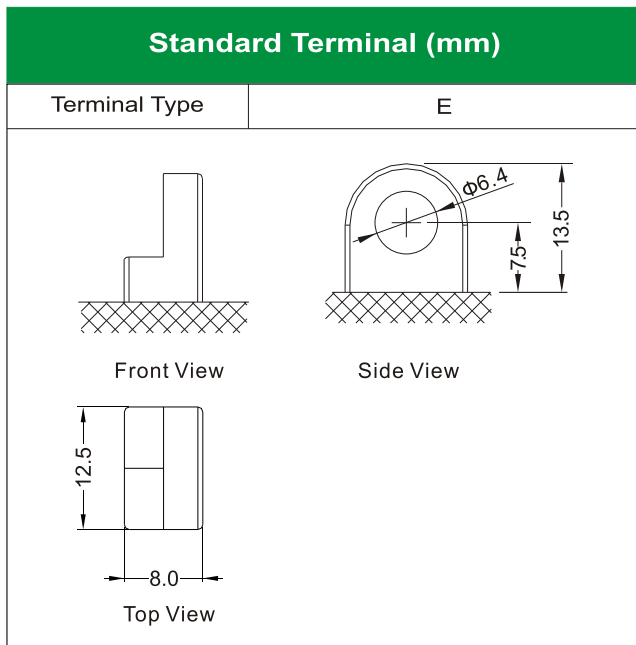

LB7C-A [12V8Ah]

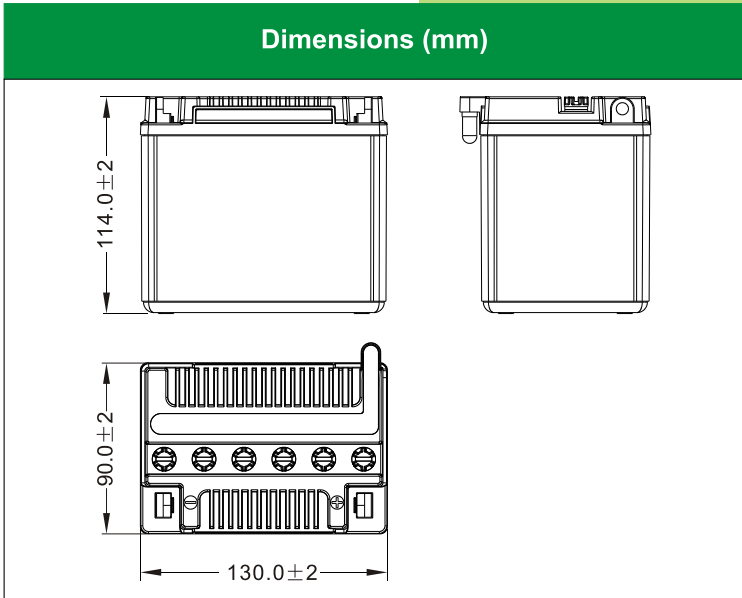

Physical Specification

Nominal Voltage	12V	
Nominal Capacity (10HR)	8Ah	
Dimension	Length	130±2mm (5.12 inches)
	Width	90±2mm (3.54 inches)
	Container Height	114±2mm (4.49 inches)
	Total Height (with Terminal)	114±2mm (4.49 inches)
Weight	Battery(with acid): Approx 2.84kg (6.26lbs)	
	Electrolyte: Approx 0.77kg (1.70lbs)	

- * High performance and dry charged high quality and flooded battery
- * Low maintenance
- * Powerful 80 cold cranking amps
- * Shipped without battery electrolyte pre-charged and ready to install
- * Replaces none battery

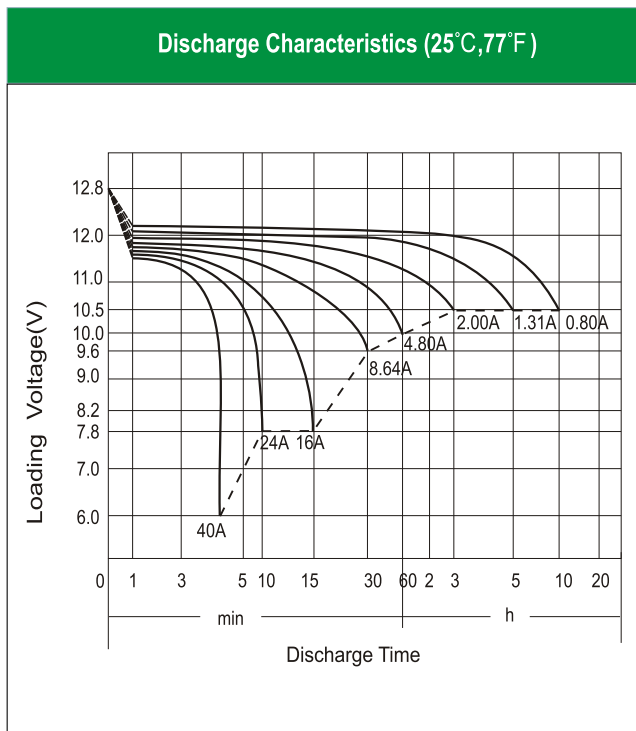

Electrical Specification

Rated Capacity	10 hour rate (0.80 A)	8.00Ah
	5 hour rate (1.31 A)	6.56Ah
	2 hour rate (2.80 A)	5.60Ah
	1 hour rate (4.80 A)	4.80Ah
	0.5 hour rate (8.64 A)	4.32Ah
Capacity affected by Temperature	40 °C (104 °F)	106%
	25 °C (77 °F)	100%
	0 °C (32 °F)	86%
	-15 °C (5 °F)	65%
Charging Methods	Full Charge	Constant-Voltage Charge: Initial charging current: less than 2.4A Voltage: 14.40 V ~ 15.00 V at 25 °C (77 °F) Charging time: 16 ~24h Constant-Current Charge: Charging current: 0.8A, when charging voltage up to 15.60V, continue to charge 2h.
	Floating Charge	No limit on Initial charging current Voltage: 13.50 V ~ 13.80 V at 25 °C (77 °F)