

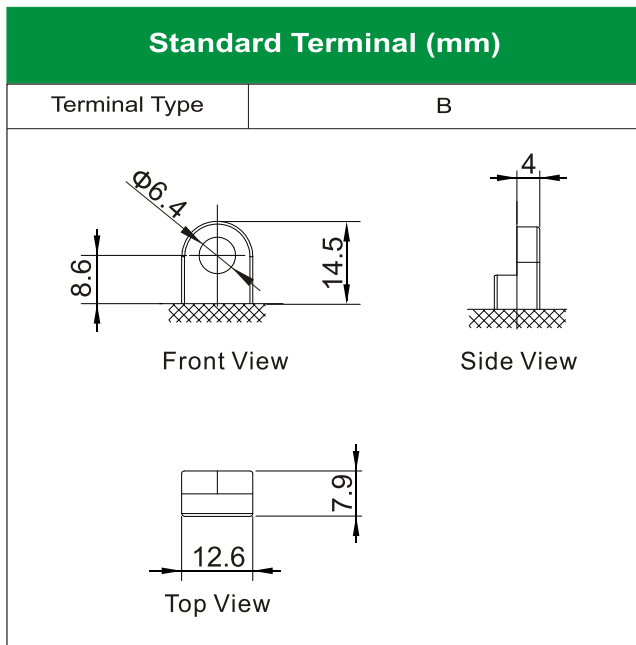

LB12AL-A2 [12V12Ah]

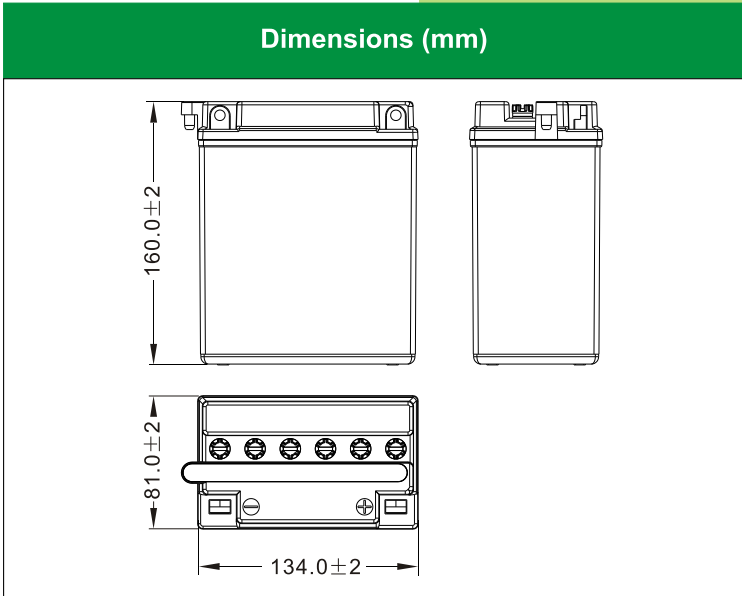

Physical Specification

Nominal Voltage	12V	
Nominal Capacity (10HR)	12Ah	
Dimension	Length	134 ± 2mm (5.28 inches)
	Width	81 ± 2mm (3.19 inches)
	Container Height	160 ± 2mm (6.30 inches)
	Total Height (with Terminal)	160 ± 2mm (6.30 inches)
Weight	Battery(with acid): Approx 4.18kg (9.22lbs) Electrolyte: Approx 1.02kg (2.25lbs)	
<ul style="list-style-type: none"> * High performance and dry charged high quality and flooded battery * Low maintenance * Powerful 150 cold cranking amps * Shipped without battery electrolyte pre-charged and ready to install * Replaces none battery 		

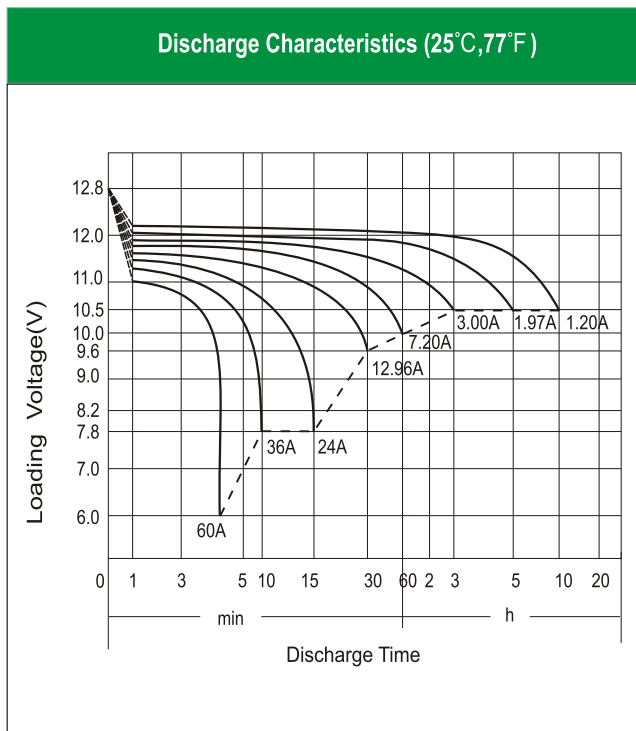

Electrical Specification

Rated Capacity	10 hour rate (1.20A)	12.0Ah
	5 hour rate (1.97 A)	9.84Ah
Capacity affected by Temperature	2 hour rate (4.20 A)	8.40Ah
	1 hour rate (7.20 A)	7.20Ah
	0.5 hour rate (12.96 A)	6.48Ah
	40 °C (104 °F)	106%
	25 °C (77 °F)	100%
	0 °C (32 °F)	86%
	-15 °C (5 °F)	65%
Charging Methods	Full Charge	Constant-Voltage Charge: Initial charging current: less than 3.6A Voltage: 14.40 V ~ 15.00 V at 25 °C (77 °F) Charging time: 16 ~24h Constant-Current Charge: Charging current: 1.2A, when charging voltage up to 15.60V, continue to charge 2h.
	Floating Charge	No limit on Initial charging current Voltage: 13.50 V ~ 13.80 V at 25 °C (77 °F)