

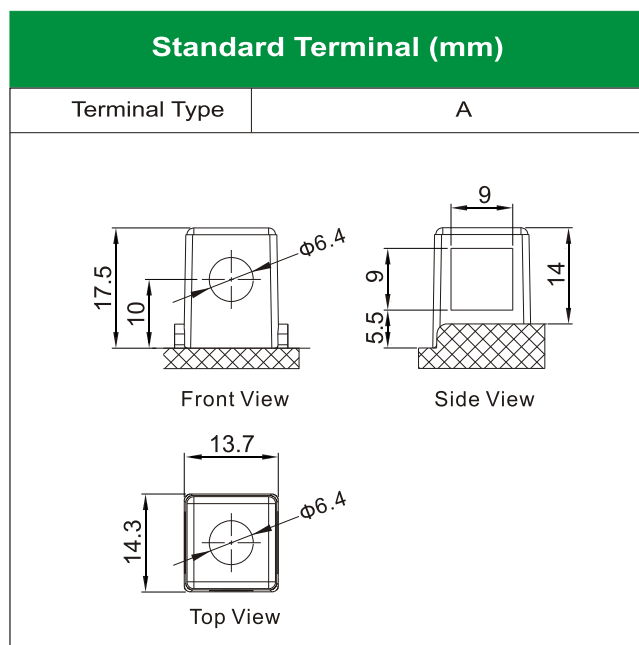

LEOCH BATTERY

EBZ14-4-1 (12V11.2Ah)

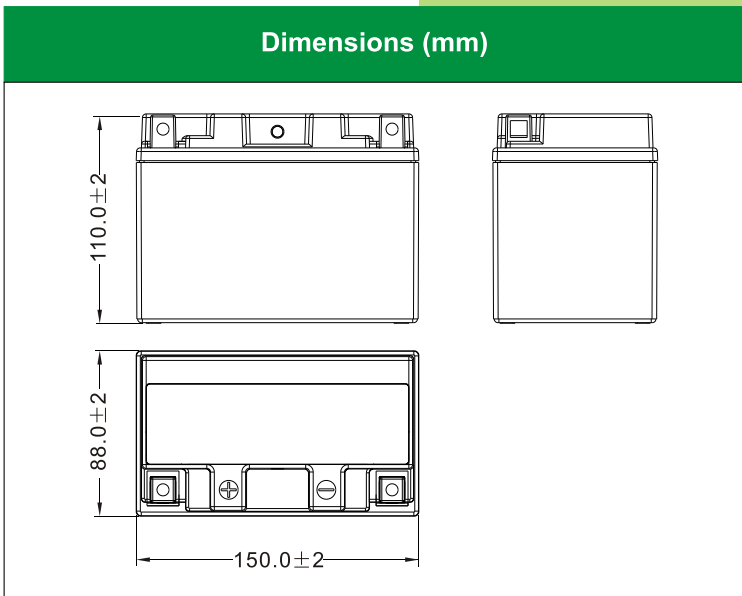

Physical Specification

Nominal Voltage	12V	
Nominal Capacity (10HR)	11.2Ah	
Dimension	Length	150 ± 2mm (5.91 inches)
	Width	88 ± 2mm (3.46 inches)
	Container Height	110 ± 2mm (4.33 inches)
	Total Height (with Terminal)	110 ± 2mm (4.33 inches)
Weight	Battery(with acid):	Approx 3.83kg (8.45lbs)
	Electrolyte:	Approx 0.68kg (1.50lbs)

- * Sealed and non-spillable AGM battery
- * Maintenance-free
- * Powerful 220 cold cranking amps
- * Shipped pre-charged and ready to install
- * Replaces none battery

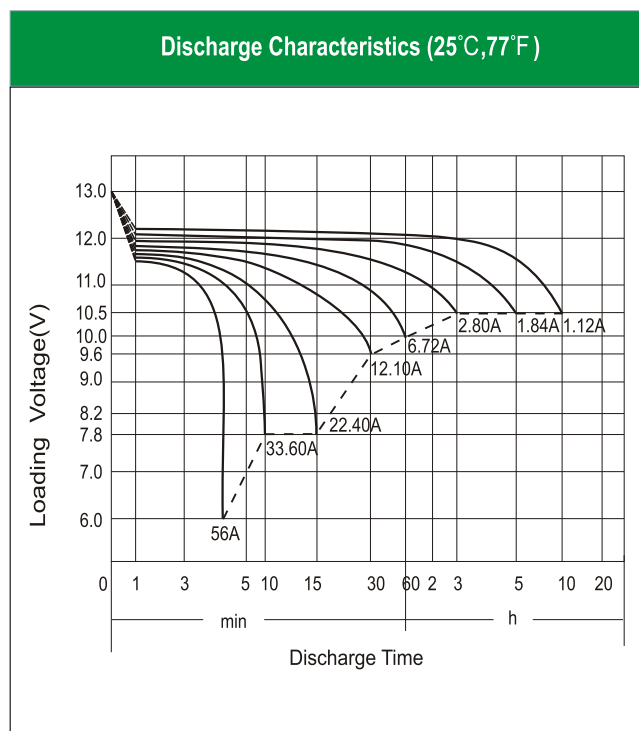

Electrical Specification

Rated Capacity	10 hour rate (1.12 A)	11.20Ah
	5 hour rate (1.84 A)	9.18Ah
	2 hour rate (3.92 A)	7.84Ah
	1 hour rate (6.72 A)	6.72Ah
	0.5 hour rate (12.10 A)	6.05Ah
Capacity affected by Temperature	40 °C (104 °F)	106%
	25 °C (77 °F)	100%
	0 °C (32 °F)	86%
	-15 °C (5 °F)	65%
Charging Methods	Full Charge	Constant-Voltage Charge: Initial charging current: less than 3.36A Voltage: 14.40 V ~ 15.00 V at 25 °C (77 °F) Charging time: 15 ~18h Constant-Current Charge: Charging current: 0.1C ₁₀ =1.12A, when charging voltage up to 14.40V, continue to charge 4h
	Floating Charge	No limit on Initial charging current Voltage: 13.50 V ~ 13.80 V at 25 °C (77 °F)