

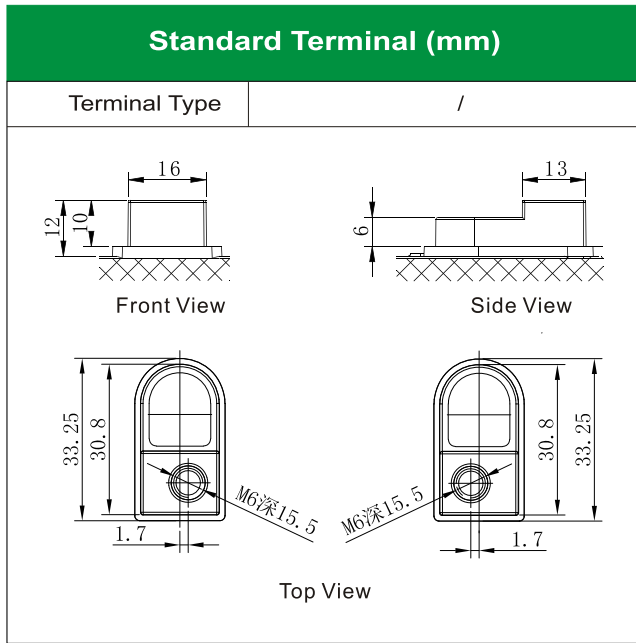

EB12D-4 [12V10Ah]

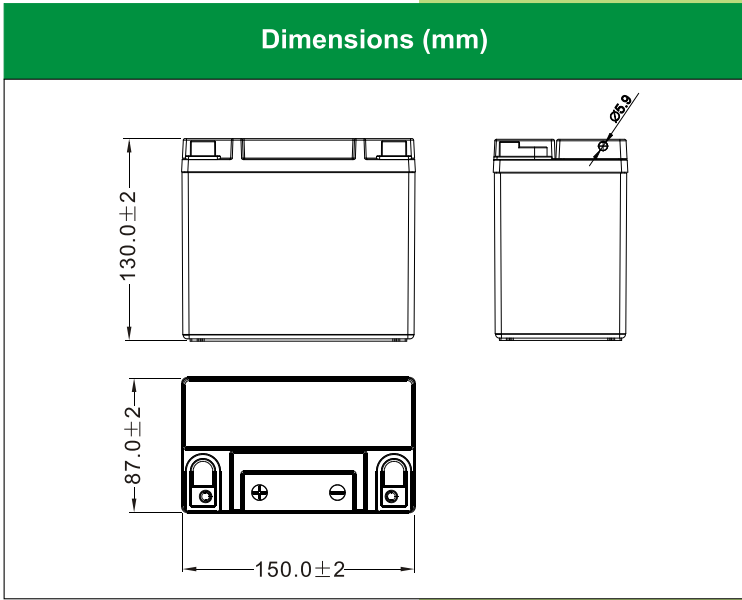

Physical Specification

Nominal Voltage	12V	
Nominal Capacity (10HR)	10Ah	
Dimension	Length	150±2mm (5.91 inches)
	Width	87±2mm (3.43 inches)
	Container Height	130±2mm (5.12 inches)
	Total Height (with Terminal)	130±2mm (5.12 inches)
Weight	Battery(with acid): Approx 4.25kg (9.37lbs)	
	Electrolyte: Approx 0.79kg (1.74lbs)	

- * Sealed and non-spillable AGM battery
- * Maintenance-free
- * Powerful 190 cold cranking amps
- * Shipped pre-charged and ready to install
- * Replaces none battery

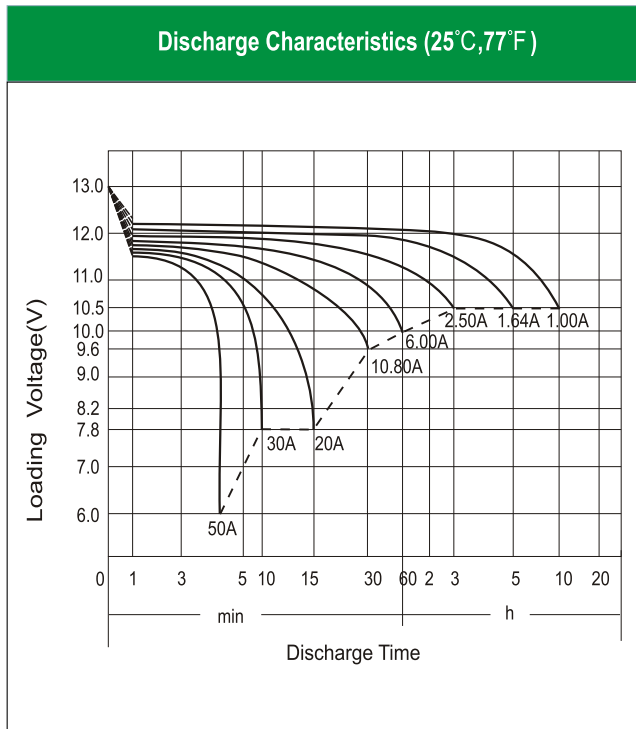

Electrical Specification

Rated Capacity	10 hour rate (1.00 A)	10.0Ah
	5 hour rate (1.64 A)	8.20Ah
	2 hour rate (3.50 A)	7.00Ah
	1 hour rate (6.00 A)	6.00Ah
	0.5 hour rate (10.80 A)	5.40Ah
Capacity affected by Temperature	40 °C (104 °F)	106%
	25 °C (77 °F)	100%
	0 °C (32 °F)	86%
	-15 °C (5 °F)	65%
Charging Methods	Full Charge	Constant-Voltage Charge: Initial charging current: less than 3.0A Voltage: 14.40 V ~ 15.00 V at 25 °C (77 °F) Charging time: 15 ~18h Constant-Current Charge: Charging current: 0.1C ₁₀ =1.00A, when charging voltage up to 14.40V, continue to charge 4h
	Floating Charge	No limit on Initial charging current Voltage: 13.50 V ~ 13.80 V at 25 °C (77 °F)