

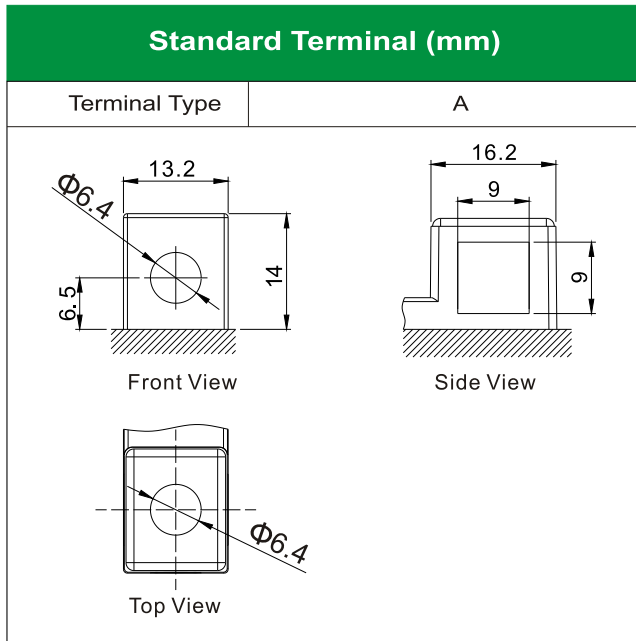

# EB10-3 [12V10Ah]

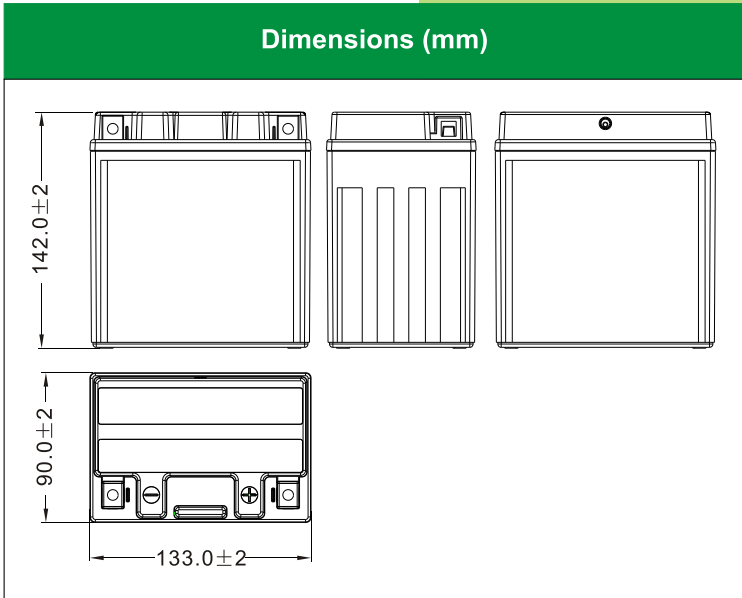

### Physical Specification

Nominal Voltage	12V	
Nominal Capacity (10HR)	10Ah	
Dimension	Length	133±2mm (5.24 inches)
	Width	90±2mm (3.54 inches)
	Container Height	142±2mm (5.59 inches)
	Total Height (with Terminal)	142±2mm (5.59 inches)
Weight	Battery(with acid): Approx 3.68kg (8.11lbs)	
	Electrolyte: Approx 0.88kg (1.94lbs)	

- \* Sealed and non-spillable AGM battery
- \* Maintenance-free
- \* Powerful 120 cold cranking amps
- \* Shipped pre-charged and ready to install
- \* Replaces EBX10L-BS battery

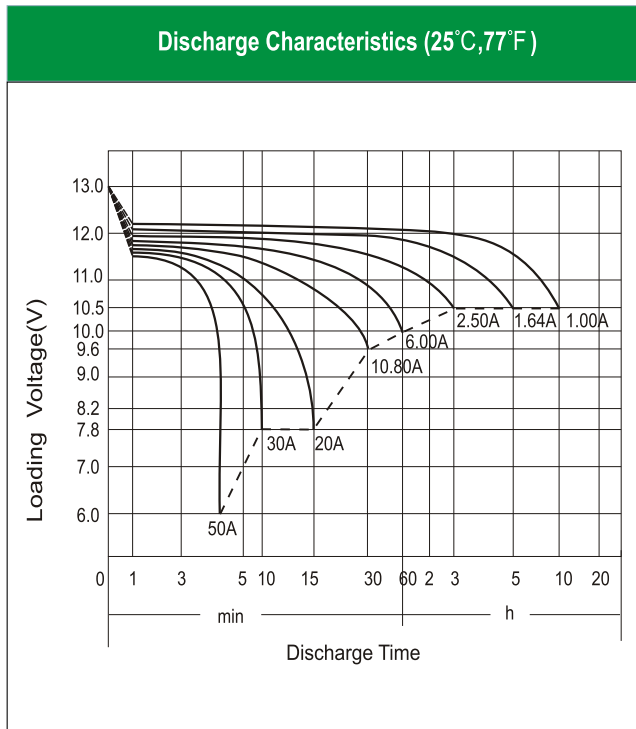

### Electrical Specification

Rated Capacity	10 hour rate (1.00 A)	10.0Ah
	5 hour rate (1.64 A)	8.20Ah
	2 hour rate (3.50 A)	7.00Ah
	1 hour rate (6.00 A)	6.00Ah
	0.5 hour rate (10.80 A)	5.40Ah
Capacity affected by Temperature	40 °C (104 °F)	106%
	25 °C (77 °F)	100%
	0 °C (32 °F)	86%
	-15 °C (5 °F)	65%
Charging Methods	Full Charge	Constant-Voltage Charge: Initial charging current: less than 3.0A Voltage: 14.40 V ~ 15.00 V at 25 °C (77 °F) Charging time: 15 ~18h Constant-Current Charge: Charging current: 0.1C <sub>10</sub> =1.00A, when charging voltage up to 14.40V, continue to charge 4h
	Floating Charge	No limit on Initial charging current Voltage: 13.50 V ~ 13.80 V at 25 °C (77 °F)