

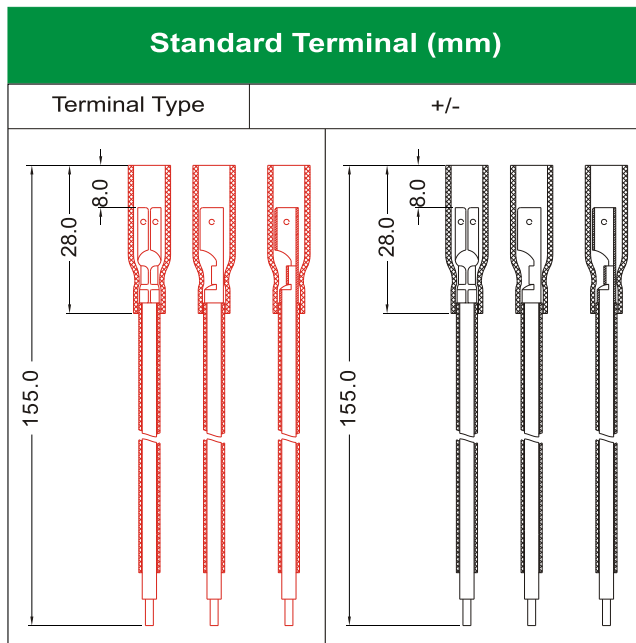

6N4-2A [6V4Ah]

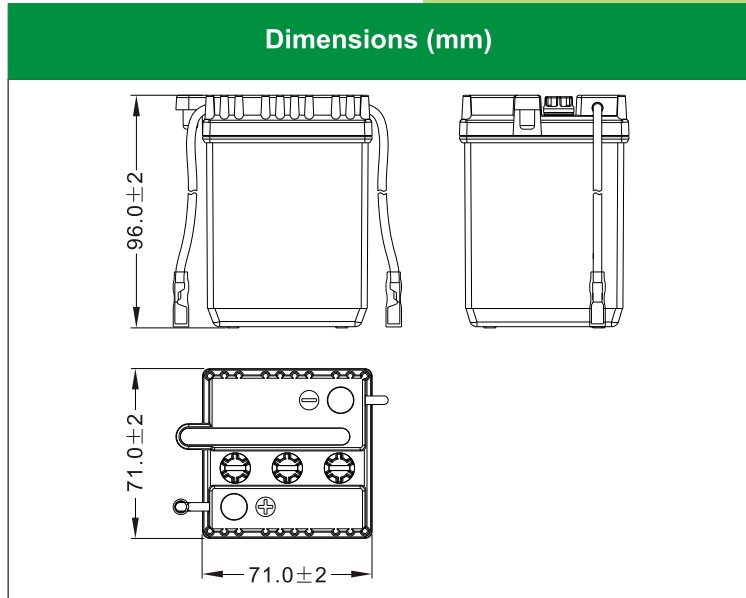

Physical Specification

Nominal Voltage	6V	
Nominal Capacity (10HR)	4Ah	
Dimension	Length	71 ± 2mm (2.80 inches)
	Width	71 ± 2mm (2.80 inches)
	Container Height	96 ± 2mm (3.78 inches)
	Total Height (with Terminal)	96 ± 2mm (3.78 inches)
Weight	Battery(with acid): Approx 0.90kg (1.98lbs)	
	Electrolyte: Approx 0.26kg (0.57lbs)	

- * High performance and dry charged high quality and flooded battery
- * Low maintenance
- * Shipped without battery electrolyte pre-charged and ready to install
- * Replaces none battery

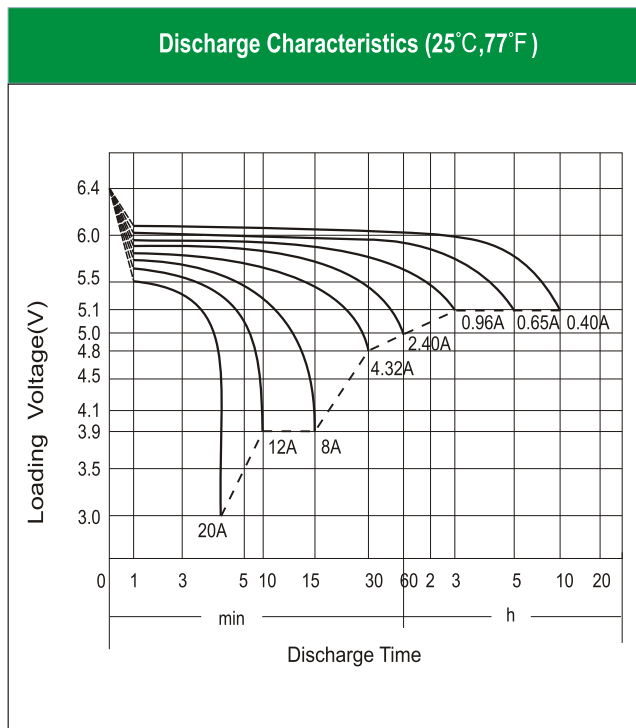

Electrical Specification

Rated Capacity	10 hour rate (0.40A)	4.00Ah
	5 hour rate (0.65A)	3.28Ah
	2 hour rate (1.40 A)	2.80Ah
	1 hour rate (2.40 A)	2.40Ah
	0.5 hour rate (4.32 A)	2.16Ah
Capacity affected by Temperature	40 °C (104 °F)	106%
	25 °C (77 °F)	100%
	0 °C (32 °F)	86%
	-15 °C (5 °F)	65%
Charging Methods	Full Charge	Constant-Voltage Charge: Initial charging current: less than 1.2A Voltage: 7.20 V ~ 7.50 V at 25 °C (77 °F) Charging time: 16 ~24h Constant-Current Charge: Charging current: 0.4A, when charging voltage up to 7.80V, continue to charge 2h.
	Floating Charge	No limit on Initial charging current Voltage: 6.75V ~ 6.90 V at 25 °C (77 °F)