

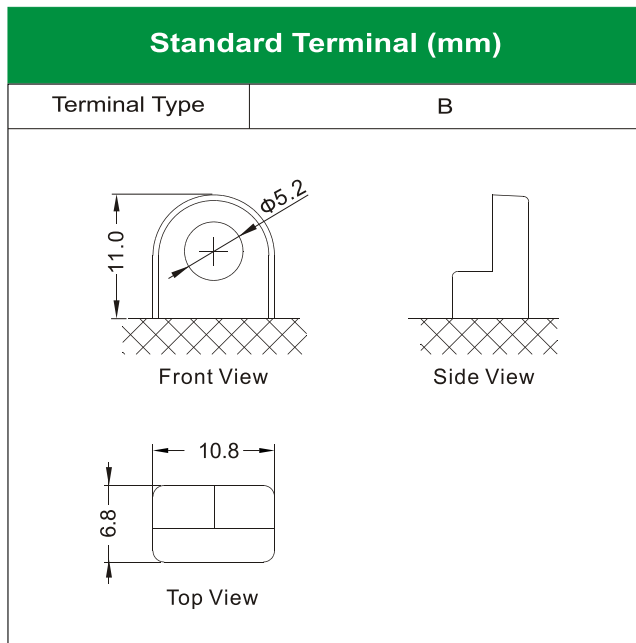

12N5.5-4B (12V5.5Ah)

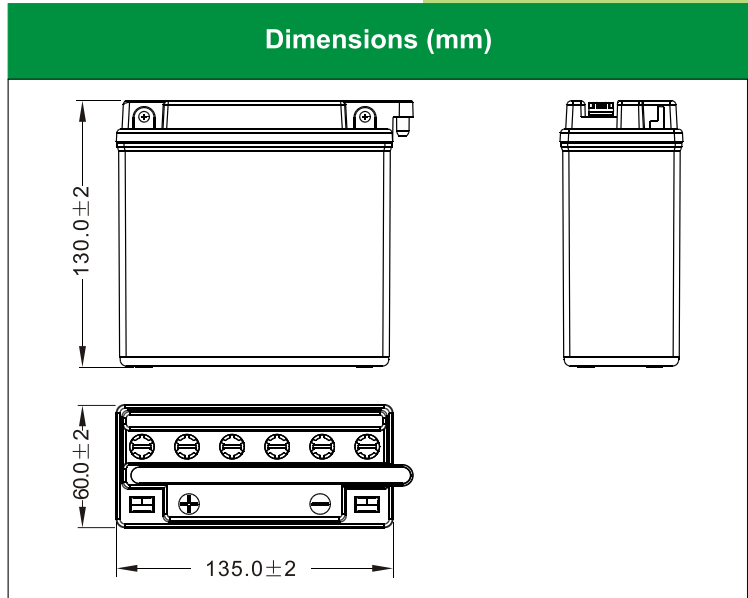

Physical Specification

Nominal Voltage		12V
Nominal Capacity (10HR)		5.5Ah
Dimension	Length	135 ± 2mm (5.31 inches)
	Width	60 ± 2mm (2.36 inches)
	Container Height	130 ± 2mm (5.12 inches)
	Total Height (with Terminal)	130 ± 2mm (5.12 inches)
Weight	Battery(with acid): Approx 2.22kg (4.89lbs) Electrolyte: Approx 0.62kg (1.37lbs)	
<ul style="list-style-type: none"> * High performance and dry charged high quality and flooded battery * Low maintenance * Powerful 44 cold cranking amps * Shipped without battery electrolyte pre-charged and ready to install * Replaces none battery 		

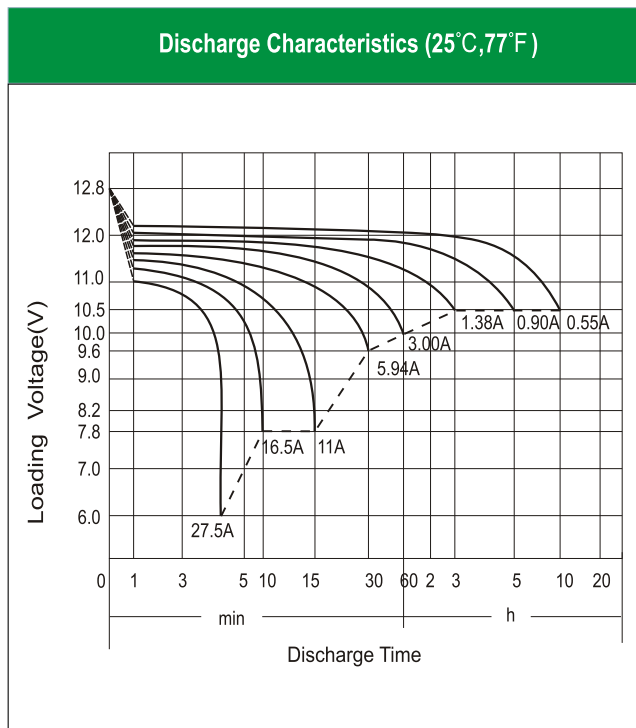

Electrical Specification

Rated Capacity	10 hour rate (0.55A)	5.50Ah
	5 hour rate (0.90 A)	4.51Ah
	2 hour rate (1.93 A)	3.85Ah
	1 hour rate (3.30 A)	3.30Ah
	0.5 hour rate (5.94 A)	2.97Ah
Capacity affected by Temperature	40 °C (104 °F)	106%
	25 °C (77 °F)	100%
	0 °C (32 °F)	86%
	-15 °C (5 °F)	65%
Charging Methods	Full Charge	Constant-Voltage Charge: Initial charging current: less than 1.65A Voltage: 14.40 V ~ 15.00 V at 25 °C (77 °F) Charging time: 16 ~24h Constant-Current Charge: Charging current: 0.55A, when charging voltage up to 15.60V, continue to charge 2h.
	Floating Charge	No limit on Initial charging current Voltage: 13.50 V ~ 13.80 V at 25 °C (77 °F)