

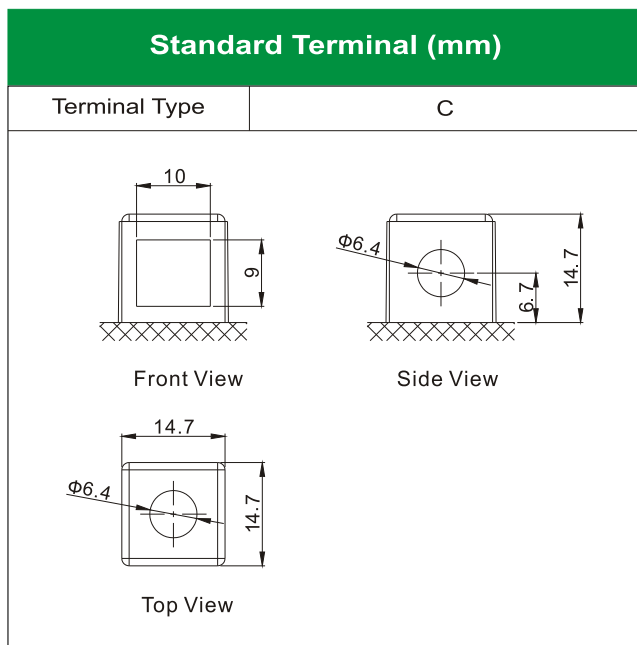

12N18-4A [12V18Ah]

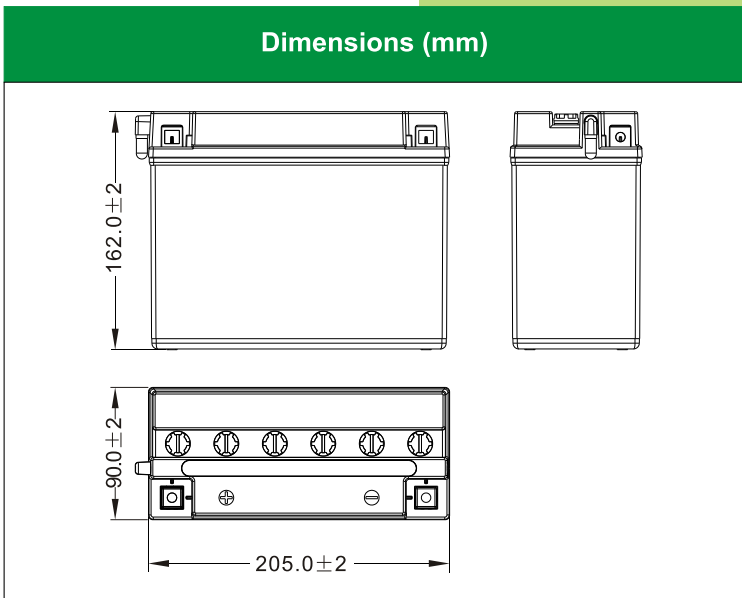

Physical Specification

Nominal Voltage		12V
Nominal Capacity (10HR)		18Ah
Dimension	Length	205 ± 2mm (8.07 inches)
	Width	90 ± 2mm (3.54 inches)
	Container Height	162 ± 2mm (6.38 inches)
	Total Height (with Terminal)	162 ± 2mm (6.38 inches)
Weight	Battery(with acid): Approx 5.96kg (13.14lbs) Electrolyte: Approx 1.70kg (3.75lbs)	
<ul style="list-style-type: none"> * High performance and dry charged high quality and flooded battery * Low maintenance * Powerful 164 cold cranking amps * Shipped without battery electrolyte pre-charged and ready to install * Replaces none battery 		

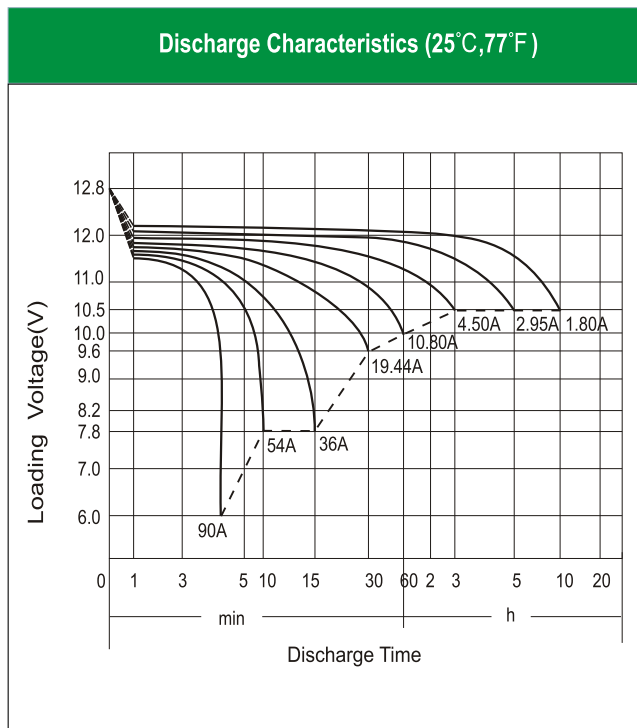

Electrical Specification

Rated Capacity	10 hour rate (1.80 A)	18.00Ah
	5 hour rate (2.95 A)	14.76Ah
	2 hour rate (6.30 A)	12.60Ah
	1 hour rate (10.80 A)	10.80Ah
	0.5 hour rate (19.44 A)	9.72Ah
Capacity affected by Temperature	40 °C (104 °F)	106%
	25 °C (77 °F)	100%
	0 °C (32 °F)	86%
	-15 °C (5 °F)	65%
Charging Methods	Full Charge	Constant-Voltage Charge: Initial charging current: less than 5.4A Voltage: 14.40 V ~ 15.00 V at 25 °C (77 °F) Charging time: 16 ~24h Constant-Current Charge: Charging current: 1.8A, when charging voltage up to 15.60V, continue to charge 2h.
	Floating Charge	No limit on Initial charging current Voltage: 13.50 V ~ 13.80 V at 25 °C (77 °F)